



Joint Defense Capabilities Study

*Improving DoD Strategic
Planning, Resourcing and Execution
to Satisfy Joint Capabilities*

**Final Report
January 2004**

Report Documentation Page

Form Approved
OMB No. 0704-0188

Public reporting burden for the collection of information is estimated to average 1 hour per response, including the time for reviewing instructions, searching existing data sources, gathering and maintaining the data needed, and completing and reviewing the collection of information. Send comments regarding this burden estimate or any other aspect of this collection of information, including suggestions for reducing this burden, to Washington Headquarters Services, Directorate for Information Operations and Reports, 1215 Jefferson Davis Highway, Suite 1204, Arlington VA 22202-4302. Respondents should be aware that notwithstanding any other provision of law, no person shall be subject to a penalty for failing to comply with a collection of information if it does not display a currently valid OMB control number.

1. REPORT DATE JAN 2004	2. REPORT TYPE	3. DATES COVERED -			
4. TITLE AND SUBTITLE Joint Defense Capabilities Studies (Improving DOD Strategic Planning, Resourcing and Execution to Satisfy Joint Capabilities)		5a. CONTRACT NUMBER			
		5b. GRANT NUMBER			
		5c. PROGRAM ELEMENT NUMBER			
6. AUTHOR(S)		5d. PROJECT NUMBER			
		5e. TASK NUMBER			
		5f. WORK UNIT NUMBER			
7. PERFORMING ORGANIZATION NAME(S) AND ADDRESS(ES) Department of Defense, Washington, DC, 20301		8. PERFORMING ORGANIZATION REPORT NUMBER			
9. SPONSORING/MONITORING AGENCY NAME(S) AND ADDRESS(ES)		10. SPONSOR/MONITOR'S ACRONYM(S)			
		11. SPONSOR/MONITOR'S REPORT NUMBER(S)			
12. DISTRIBUTION/AVAILABILITY STATEMENT Approved for public release; distribution unlimited					
13. SUPPLEMENTARY NOTES The original document contains color images.					
14. ABSTRACT see report					
15. SUBJECT TERMS					
16. SECURITY CLASSIFICATION OF:			17. LIMITATION OF ABSTRACT	18. NUMBER OF PAGES	19a. NAME OF RESPONSIBLE PERSON
a. REPORT unclassified	b. ABSTRACT unclassified	c. THIS PAGE unclassified		127	



Joint Defense Capabilities Study

*Improving DoD Strategic
Planning, Resourcing and Execution
to Satisfy Joint Capabilities*

**Final Report
January 2004**

This document reflects the views of the Joint Defense Capabilities Study Team and is not the official position of the Department of Defense.

Executive Summary

In March 2003, the Secretary of Defense chartered a study—formally named the Joint Defense Capabilities Study—to examine how the Department of Defense (DoD) develops, resources, and provides joint capabilities. The Secretary selected the Honorable Pete Aldridge, former Under Secretary of Defense for Acquisition, Technology, and Logistics, to lead the study. The Study Team’s task was to examine and improve DoD processes for determining needs, creating solutions, making decisions, and providing capabilities to support joint warfighting needs. Based on that examination, the Study Team developed streamlined processes and alternative organizations to better integrate defense capabilities in support of joint objectives.

Why change? Although the current processes have produced the best armed forces in the world, they do not optimize our investment in joint capabilities to meet current and future security challenges. From its discussions with senior personnel in the Office of the Secretary of Defense (OSD), Joint Staff, Services, and Combatant Commands (CoComs), along with reviews of past studies and analyses of current processes, the Study Team found the following:

- ◆ *Services dominate the current requirements process.* Much of DoD’s focus is on Service programs and platforms rather than capabilities required to accomplish Combatant Command missions. A Service focus does not provide an accurate picture of joint needs, nor does it provide a consistent view of priorities and acceptable risks across DoD.
- ◆ *Service planning does not consider the full range of solutions available to meet joint warfighting needs.* Alternative ways to provide the equivalent capability are not adequately considered—especially if the alternative solutions are resident in a different Service or Defense Agency.
- ◆ *The resourcing function focuses senior leadership effort on fixing problems at the end of the process, rather than being involved early in the planning process.* OSD programming guidance exceeds available resources and does not provide realistic priorities for joint needs. “Jointness” is forced into the program late in the process during an adversarial and time-consuming program review. The resulting program does not best meet joint needs, or provide the best value for the nation’s defense investment.

Capabilities-Based Process

The Study Team recommends a capabilities-based process for identifying needs, creating choices, developing solutions, and providing capabilities. The recommended process differs from the current process in the following ways:

- ◆ *Joint needs would form the foundation for the defense program.* These needs must be developed using a consistent view of priorities and risks, provided by the Secretary of Defense. Combatant Commanders would have major input into the formulation of joint needs.
- ◆ *Planning for major joint capabilities would be accomplished at the Department, rather than Component level.* A process in which all stakeholders participate would encourage innovation and seek the “best solution” to meet joint capability needs. Needs would be expressed as “capabilities” or “desired effects” to allow for the widest range of possible solutions. Solutions would be evaluated using open and explicit analysis to provide the best possible information for decision makers.
- ◆ *Senior leaders would focus on providing guidance and making decisions in the “front end” of the process.* The Secretary of Defense would provide strategic direction for capabilities planning and be iteratively engaged in the entire process. Major issues currently addressed in the program review would be examined early in the process, when there is more time for deliberate analysis and greater solution space for the Secretary’s decision making.

As shown in Figure 1, the new process has four major elements: strategy, enhanced planning, resourcing, and execution and accountability. These elements differ from the processes they replace in the following ways:

- ◆ *Strategy.* Combatant Commanders would be assigned a much larger role in shaping the defense strategy articulated in Strategic Planning Guidance (SPG). The SPG would focus on strategic objectives, priorities, and risk tolerance, rather than on programmatic solutions. It would initiate the planning process and dictate those areas where joint planning efforts must focus.
- ◆ *Enhanced planning.* The Enhanced Planning Process would support assessment of capabilities to meet joint needs. Military needs would be identified primarily through Combatant Command operational plans and operating concepts. Enterprise (non-warfighting) needs would be identified by the Services and OSD.
- ◆ *Resourcing.* The Joint Programming Guidance (JPG) would reflect the decisions made in the Enhanced Planning Process and provide fiscally executable guidance for the development of the Components’ programs.

Because the guidance would be fiscally executable, the remainder of the resourcing process would be relatively simple, and the program and budget reviews would be reduced in scope and level of effort.

- ◆ *Execution and accountability.* The new process would focus on performance assessment and be organized around the capabilities categories and objectives outlined in the SPG and addressed in the JPG. Outcome-oriented capability categories spanning both operational and enterprise functions would serve as the framework for every phase of the new process. The SPG, Enhanced Planning Process, JPG, internal defense budget, and assessment report would be organized by capability categories.

Figure 1. Simplified End State Process Model

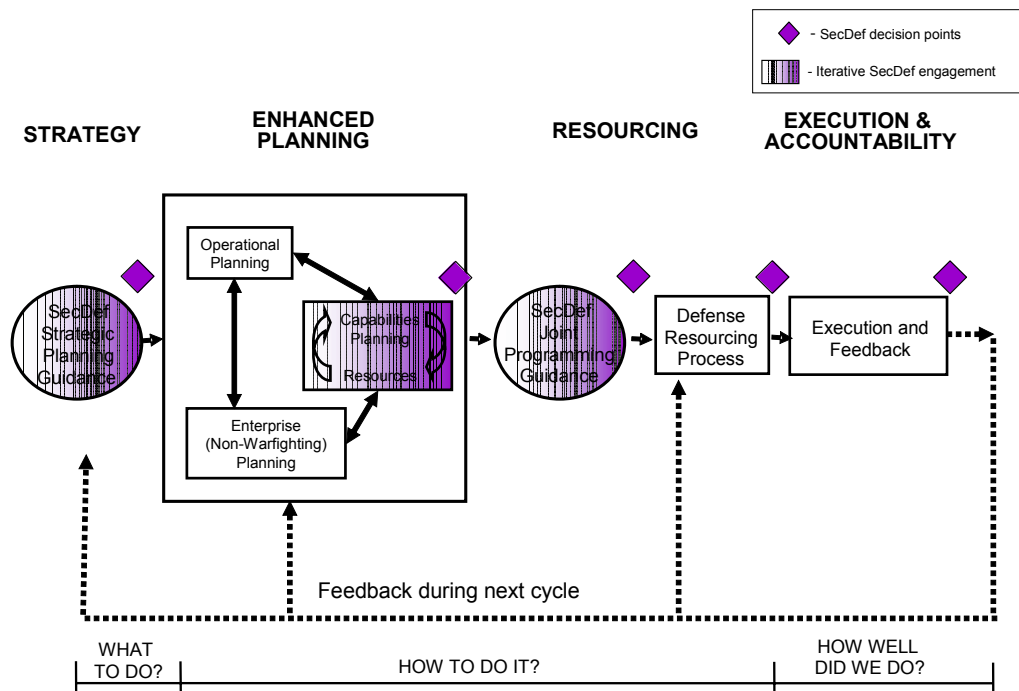

Organizational Alternatives

The Study Team developed first- and second-order organizational alternatives. The first-order organizational alternatives address the Department/corporate-level changes needed to implement the new capabilities-based process. These alternatives are built around the Enhanced Planning Process. The second-order organizational alternatives address changes within major enterprise functions—acquisition; research, development, test, and evaluation; logistics; infrastructure; and workforce planning—to accomplish end state planning and execution processes. For both levels of changes, the Study Team developed a set of moderate, aggressive, and radical alternatives, based on the level of change proposed.

In general, the moderate alternative would use the existing OSD and Joint Staff structure, with minor modifications, to partially achieve the end state through the use of matrixed capability teams and ad hoc organizations. The aggressive alternative would reorganize those parts of OSD and the Joint Staff that support capabilities-based planning and resource allocation. The radical option would combine duplicative functions in OSD and the Joint Staff to support capabilities-based planning and resourcing at the Department-level; it would also require a major reorganization.

Although the focus of the organizational alternatives in this study is on OSD and the Joint Staff, additional realignments may be beneficial. Elements that define joint capabilities (predominantly CoComs) and provide a wide range of alternatives to capability needs (predominantly Services and Agencies) should consider internal realignment to improve integration with the new process.

Implementation

The Study Team's recommendations are substantial. Consequently, any effort to implement them would likely encounter bureaucratic resistance. Using an implementation team to manage the recommended changes will therefore be critical to keeping the changes on track, particularly during the transition period. To be effective, this implementation team should be led by an individual who has direct access to the leadership of the Department, especially the Secretary and Deputy Secretary of Defense. The head of the implementation team and supporting staff would need to establish a Department-wide governance process to drive the change effort. This process should clearly spell out what needs to be done, who needs to do it, and when it needs to be completed. Department leadership should receive regular progress reviews.

Equally important is the need to communicate the need for change, the goal of the change effort, and the organization's progress toward meeting that goal. The implementation team, working closely with Public Affairs, should spearhead efforts to create an external and internal communication strategy.

Contents

Chapter 1 Introduction	1-1
BACKGROUND.....	1-1
STUDY APPROACH	1-2
Chapter 2 Capabilities-Based Process	2-1
OVERVIEW	2-1
THE CURRENT PROCESS—WHAT’S BROKEN	2-2
An Unclear Defense Strategy.....	2-3
Stovepiped Capabilities Planning	2-4
Inefficient Resourcing Process	2-5
Weak Feedback and Accountability	2-5
THE “END STATE” PROCESS—WHAT’S NEEDED.....	2-6
A New Framework—Joint Capability Categories	2-7
Senior Oversight—The Strategic Planning Council.....	2-8
Top-Down Strategy Development	2-9
Capabilities Planning—Enhanced Planning Process	2-10
“Born Joint” Resourcing Process.....	2-16
Improved Assessment and Feedback Process.....	2-17
Process Timeline.....	2-18
Chapter 3 Organizational Alternatives	3-1
DEPARTMENT/CORPORATE LEVEL (FIRST-ORDER ALTERNATIVES)	3-1
Alternative 1: Enhance the Functional Capability Boards.....	3-3
Alternative 2: Establish a Corporate Planning Staff.....	3-4
Alternative 3: Streamline the Executive Staff	3-5
FUNCTIONAL LEVEL (SECOND-ORDER ALTERNATIVES)	3-7
Acquisition.....	3-7
RDT&E.....	3-10
Logistics.....	3-12

Infrastructure.....	3-15
Workforce Planning.....	3-18
Chapter 4 Implementation	4-1
WHY CHANGE.....	4-1
LEADING CHANGE	4-1
CREATING AN IMPLEMENTATION TEAM.....	4-2
SUMMARY.....	4-4
Appendix A Implementation Memoranda	
Appendix B Products for Secretary of Defense and Senior Leadership Review Group	
Appendix C Key Assumptions, Guidance, and Other Studies	
Appendix D Strategy: Outline for Secretary of Defense Strategic Planning Guidance	
Appendix E Enhanced Planning	
Appendix F Capability Categories	
Appendix G Resourcing	
Appendix H Performance	
Appendix I Steering Group Members	
Appendix J Study Team Members	
Appendix K Chronology/Decision Points	
Appendix L Organizational Alternatives—First Order	
Appendix M Organizational Alternatives—Second Order	

FIGURES

Figure 1-1. Overview of Capabilities-Based Approach.....	1-1
Figure 2-1. Relative Emphasis in “As-Is” and End State Processes.....	2-2
Figure 2-2. “As-Is” Versus End State Comparison	2-3
Figure 2-3. Simplified End State Process Model.....	2-6
Figure 2-4. Capability Categories	2-8
Figure 2-5. Simplified Capabilities Planning Process	2-11
Figure 2-6. New Roles and Responsibilities for Joint Needs	2-12
Figure 2-7. Department-Level Analysis Engine	2-13
Figure 2-8. Analysis Engine Activities	2-14
Figure 2-9. Major Trades and Integration.....	2-15
Figure 2-10. Capabilities Decision Process	2-15
Figure 2-11. Activity Calendar	2-19
Figure 3-1. Overall Process with Organizational Change Requirements	3-2
Figure 3-2. Alternative 1—Moderate Change	3-3
Figure 3-3. Alternative 2—Aggressive Change.....	3-5
Figure 3-4. Alternative 3—Radical Change	3-6
Figure 4-1. Successful Change Effort with Handoff	4-4

Chapter 1

Introduction

The 2001 Quadrennial Defense Review directed the Department of Defense (DoD) to pursue a capabilities-based approach to defining its needs. This approach is markedly different from the traditional threat-based approach because it focuses on delivering capabilities to meet a wide range of security challenges rather than defeating a specific adversary.

In March 2003, the Secretary of Defense (SecDef) chartered the Joint Defense Capabilities Study to examine the process and organizational changes necessary to implement a capabilities-based approach across the Department.

BACKGROUND

The United States cannot definitively predict who its next adversary will be or where the next conflict will occur. A capabilities-based approach would help mitigate this uncertainty by emphasizing the nation's ability to shape the battle-field, regardless of whom we fight or where we fight. Figure 1-1 is an overview of a capabilities-based approach.

Figure 1-1. Overview of Capabilities-Based Approach

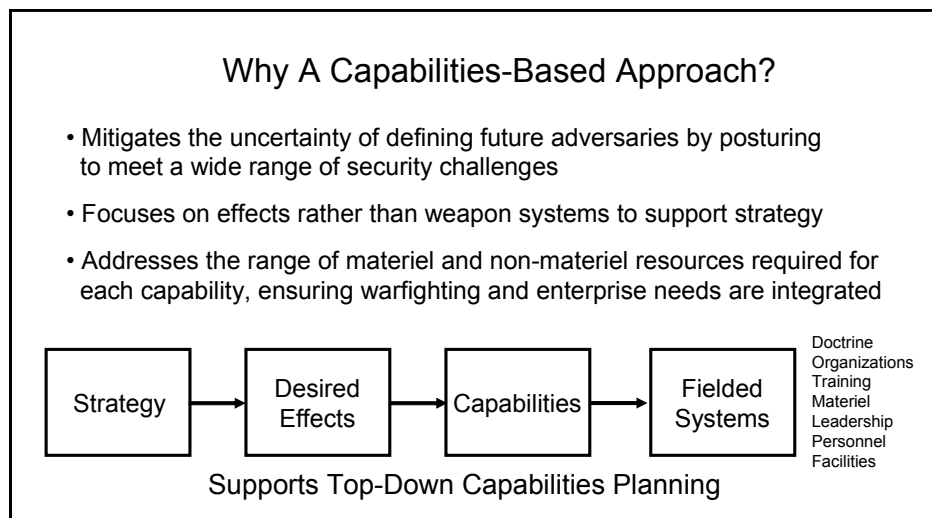

A capabilities-based approach elevates the discussion of joint needs to a more strategic level, centering on desired effects rather than specific weapon systems and platforms. In addition, strategic objectives would frame the desired effects, which in turn would define the needed capabilities, and ultimately the platforms and weapon systems to be acquired. This approach would reverse our current

practices of packaging weapon systems and platforms into capabilities, assessing what effects we can achieve on the battlefield, and planning operations based on those achievable effects. Because a capabilities-based approach begins at the strategic level, top-down guidance should be easier to incorporate, making the entire process more responsive to senior leader decisions.

Another advantage to a capabilities-based approach is that every capability would be broken into doctrine, organizational, training, materiel, leadership, personnel, and facilities elements. As a result, it would consider all resources when planning for capabilities. It also would consider enterprise and warfighting needs simultaneously, supporting a fiscally constrained resourcing process.

STUDY APPROACH

The Honorable Pete Aldridge, former Under Secretary of Defense for Acquisition, Technology, and Logistics led the Joint Defense Capabilities Study. Mr. Aldridge was supported by a Study Team drawn from selected offices within the Office of the Secretary of Defense (OSD), the Joint Staff, and the Services. The study also drew on the expertise of the Combatant Commands (CoComs) and other organizations.

The Study Team began its work by researching the many recent and ongoing studies that have dealt with DoD internal processes. A complete listing of these study efforts is included in Appendix C.

This report presents the Study Team's results. It describes an improved Department-wide process for delivering the greatest achievable joint warfighting and support capabilities from the nation's defense investment, and it identifies alternative organizational changes needed to support the new process. The report also briefly discusses implementation considerations.

The Study Team received considerable guidance and support from the SecDef and other senior leaders within the department. The SecDef received monthly briefings and actively provided feedback and direction. The Senior Leadership Review Group discussed the study results and Mr. Aldridge's recommendations on 12 September and 31 October 2003. At the 31 October meeting, the SecDef signed a memorandum announcing his decision to implement the new process.

Chapter 2

Capabilities-Based Process

OVERVIEW

This study advocates a capabilities-based process for determining and satisfying joint needs. Under that process, joint needs would be defined with a Department-wide view based on extensive input from all users of defense capabilities, particularly the CoComs. Capabilities planning would characterize and quantify both warfighting and enterprise needs, ensuring that doctrine, organizational, training, personnel, leadership, and facilities issues are considered simultaneously with platforms, weapon systems, and costs. The key differences from the current approach are summarized below:

- ◆ Attempts to meet needs and maximize output would occur at the joint level, rather than individual Component level.
- ◆ Strategic objectives and joint needs would be expressed in terms of outcomes (what is to be accomplished) instead of specific platforms and systems.
- ◆ An array of innovative solutions to joint needs, including trade analysis across Services and Defense Agencies, would be available to determine the best options.
- ◆ A wide range of threats would be addressed rather than a single or primary threat in meeting the needs of the current and future warfighter.

The process proposed by the Joint Defense Capabilities Study begins with a unified, resource-informed strategy that would guide planning, resourcing, and budget execution. A collaborative analytical process would define joint needs that drive the defense program, and the Services would offer competing solutions to meet those needs. Senior leadership would be engaged early, when greater decision space exists, to provide top-down guidance and make decisions on key issues. Performance reporting would be focused on outcomes to ensure that delivered capabilities fully support defense strategy. The goal of this process would be to move the Department from where it is now (the “as-is”) to a desired “end state.”

The desired end state is a streamlined, collaborative, yet competitive process that produces a fully integrated joint warfighting capability.

Transitioning to the proposed process requires changes in four major defense activities: strategy development, capabilities planning, resourcing, and program execution and accountability. The process has several tenets:

- ◆ Strategic guidance reflects decisions by the senior leadership on defense objectives and acceptable levels of risk.
- ◆ The defense program is “born joint,” in an objective analytical process that responds to strategic guidance.
- ◆ Programmatic guidance is fiscally constrained, so the resourcing process is streamlined and simplified.
- ◆ A review process assesses and reports on how well the Department is acquiring the capabilities needed to achieve the defense strategy.

Overall, this process emphasizes articulation of strategy and joint capabilities planning rather than focusing on weapons system and platform programmatic. Figure 2-1 depicts this shift in emphasis.

Figure 2-1. Relative Emphasis in “As-Is” and End State Processes

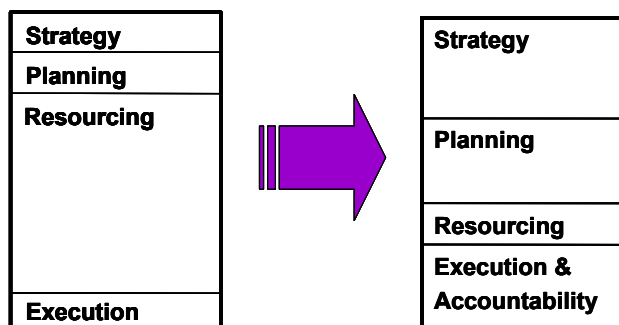

A definitive front-end strategy and planning guidance would define the joint needs, drive a more streamlined and less labor-intensive resourcing process, and facilitate outcome-based resource allocation and execution management. This shift would provide guidance on risk and priorities as a part of the strategy development process and enable early consideration of major program alternatives at the joint capability level in the planning process.

THE CURRENT PROCESS—WHAT’S BROKEN

Although the current process has produced the best armed forces in the world, DoD has significant room for improvement, particularly as it positions itself for the uncertainties of tomorrow. Specifically, DoD needs to improve its ability to plan, resource, and field joint capabilities and to ensure that the best solutions are brought forward and implemented. Improving interoperability among the Services is key, which requires greater coordination and collaboration at the department

level. Figure 2-2 summarizes the problems in the current process and lists key attributes of the end state process. The following subsections discuss how the current process prevents efficient and effective allocation of resources to provide the needed capabilities.

Figure 2-2. “As-Is” Versus End State Comparison

Major Process	“As-Is” Problems	End State Attributes
Strategy	<ul style="list-style-type: none"> • Multiple documents • Heavy emphasis on programmatic guidance • Guidance is not integrated, prioritized, or resource-informed 	<ul style="list-style-type: none"> • Single translation of NSS into Department objectives, priorities and risk tolerance • Conceptual framework and focus for planning and capability development • Resource-informed Strategic Planning Guidance
Planning	<ul style="list-style-type: none"> • Services and Defense agencies define needs at the Component level • Focus is on platforms and weapon systems rather than capability outputs • Services and Defense agencies conduct trades within their Component 	<ul style="list-style-type: none"> • Outcome-focused joint needs are defined up front in the process • CoComs drive joint needs; Services provide solutions • Capabilities trade-off analysis is conducted at the Department-level • Developed collaboratively, with extensive involvement by all stakeholders
Resourcing	<ul style="list-style-type: none"> • Components’ programs cannot comply with all of the requirements of the DPG • Adversarial, labor-intensive process • Senior leadership forces “Jointness” into the process at the end, with great effort • Gaps and excesses in Joint capabilities render the Defense program cost-ineffective 	<ul style="list-style-type: none"> • Joint Programming Guidance is provided early and is fiscally constrained • Streamlined, efficient process produces early decisions • Senior leadership attends to issues of compliance and executability
Execution and Accountability	<ul style="list-style-type: none"> • Focus on expenditure / adherence to regulations • Prolonged and complicated process to produce new capabilities • Human capital planning and costs are not addressed • Logistics & acquisition cycle time and support are not timely or cost-effective • Execution data not useful for DoD decision making 	<ul style="list-style-type: none"> • Focus on performance / results • Reduced cycle-time so that capabilities are developed to meet emerging needs • Human capital managed strategically • All warfighting and enterprise capability costs considered and continually refreshed • Execution performance serves as a starting point for next planning cycle

An Unclear Defense Strategy

Defense strategy is not articulated in a concise form that provides integrated department-wide objectives, priorities, and roles as a framework for planning joint capabilities development. It is conveyed in numerous documents, many of which are outdated or contradictory.

Much of the material in the current strategy documents originates in working groups and committees. This bottom-up process frequently results in a signature-ready document. But, it does not support early senior leadership involvement to shape strategic guidance up-front.

Furthermore, the Department's planning guidance is platform centric. Specific programmatic, communicated before Department-wide planning is conducted, often reflect "special interest" lobbying rather than sound analysis. Defense guidance, as written today, tends to foreclose the planning process with specific programmatic guidance, without any analytic transition from the strategic guidance that begins the process to the programmatic guidance that ends it. There should be a clear linkage from defense strategy to the capabilities needed to support it and to decisions on how those capabilities need to be changed. The CoComs have a unique perspective in this regard, but today's process uses that perspective only on the margins.

The problems arising from the lack of a single, well-articulated defense strategy are exacerbated by guidance that is neither prioritized nor fiscally constrained. As a result, those receiving the guidance are left to determine what aspects should be implemented. Strategic direction breaks down and loses credibility.

Stovepiped Capabilities Planning

The Services dominate planning for capabilities, even when those capabilities are inherently joint and specifically support the CoComs. Historically, the Services have defined the needs, developed the alternatives, and selected and resourced the solutions. These actions are typically accomplished in a stovepiped fashion, with minimal consideration for cross-Service trades or multi-Service efficiencies.

Under the old Requirements Generation System, Services presented their mission need statements to the Joint Requirements Oversight Council (JROC) for approval. Because it approached candidate requirements and resources on a case-by-case basis rather than with a DoD-wide view, the JROC was predisposed to accept Service-defined needs. In addition, the JROC was unable to prioritize needs, particularly across Services, which made it difficult to terminate lower priority programs later in the process.

The Services were primarily responsible for creating mission need statements within their assigned domains. Needs that were uniquely joint were slow to be identified and filled when no specific Service had responsibility. In some cases, joint needs were incongruent with the Services' strategic direction or they competed with Service priorities and were therefore ignored.

Combatant Command involvement was minimal. Their needs were implicitly communicated through operational plans and Integrated Priorities Lists (IPLs) rather than explicitly through requirements documents. However, the Services viewed the IPLs as unconstrained wish lists, while the CoCom saw the IPLs as largely ignored until the Services were forced to fund selected aspects during program review. In the aggregate, the lack of strong CoCom influence resulted in capabilities being "pushed" to them rather than identifying and "pulling" the capabilities they needed.

The new Joint Capabilities Integration and Development System (JCIDS) addresses many of the above problems, but the analytical capability continues to reside predominantly in the Services. The CoComs have an “on ramp” to the JROC via capability change recommendations, but it remains unclear if the Services will embrace those recommendations because they compete with Service priorities. Also, cross-Service prioritization continues to be a challenge, and enterprise needs do not receive the same degree of attention as warfighting needs.

To solve many of these problems, DoD has undertaken several initiatives to implement a capabilities-based approach for determining military needs. Primarily, it has started developing the necessary tools to support such an approach, such as metrics, methods, and capability categories. However, a capabilities-based approach has not yet been institutionalized across the Department.

Inefficient Resourcing Process

Because the Services receive more guidance than they can resource, they are forced to make their own tradeoffs to comply with fiscal constraints. Service needs routinely compete with joint needs, with tough choices required to create a fiscally responsible program. Service decisions made in their own best interests are then second-guessed by the CoComs, the Joint Staff, and OSD, and often are overturned during program review. Consequently, the Services have little incentive to fund joint needs before program review.

This process has resulted in an annual “train wreck” during program review. The train wreck occurs because joint needs are forced into the process after each Service has developed its integrated program. The resulting budget does not optimize capabilities at either the Department or the Service level. The effort to modify the program and the budget late in the process is labor intensive and often adversarial.

Weak Feedback and Accountability

A significant portion of DoD’s workforce is dedicated to ensuring compliance with budgetary rules and regulations. This effort focuses on how money is being spent rather than on determining whether the capabilities being acquired support the overall strategy. As a result, too much emphasis is placed on monetary input rather than capabilities output, and much of the submitted information does not support senior leader decision making. Generally, reports, including budget exhibits, are compiled to meet an external customer such as the Congress or the Office of Management and Budget. Senior decision makers need to know how well the Department is being resourced to meet current and future mission requirements—a message that has not been clearly presented in the aggregate.

The CoComs have not played a significant role in this part of the process. As the authors of the Department’s operational plans, they are best suited to determine if the right capabilities are being delivered, which means they should be driving the

strategy and feasibility assessments. Their lessons learned also should be given a formal process for consideration in the strategy or planning processes.

THE “END STATE” PROCESS—WHAT’S NEEDED

The Study Team developed a general process model for achieving the desired end state. Figure 2-3 depicts a simplified model of the end state process.

Figure 2-3. Simplified End State Process Model

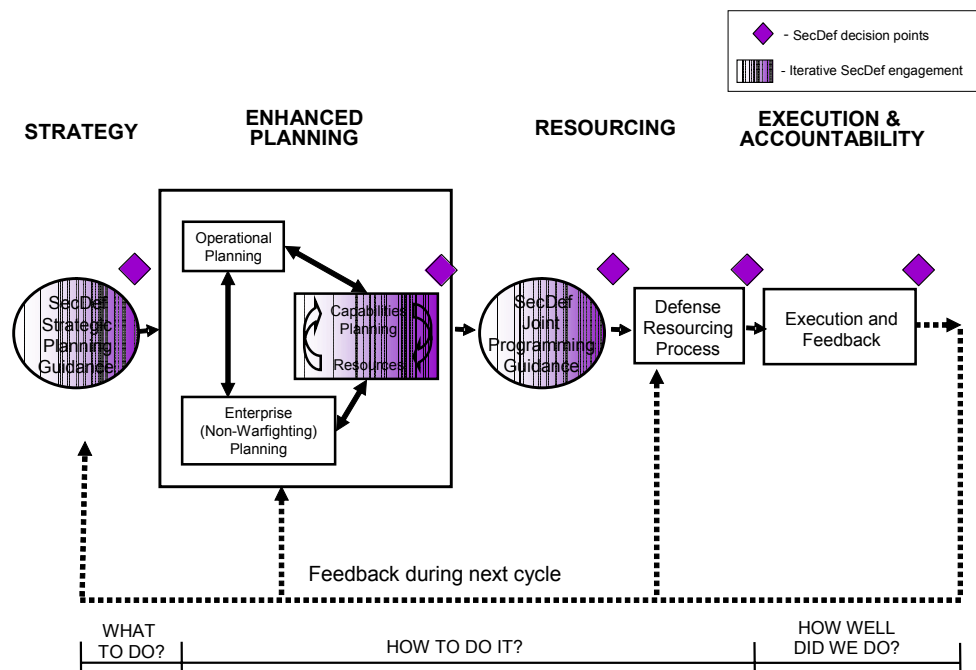

The new process model differs from how business is done today in several major respects. First, CoComs would be given the opportunity to play a larger role in shaping defense strategy, which is articulated in the Strategic Planning Guidance (SPG). The SPG, which initiates the planning process, would define those areas where joint planning efforts will focus, particularly where cross-Service capabilities tradeoffs may be appropriate.

The planning process must allow for three distinct activities:

- ◆ Identifying joint needs through the use of effects-based terms
- ◆ Providing a wide range of alternatives to meet those needs
- ◆ Analyzing cross-Service trades to select the best options.

The CoComs would play a leading role in the first activity. Joint needs are driven by operating concepts and the unique demands of various theaters of operation.

The Services would also play a vital role by offering innovative approaches to warfighting within their functional specialties. At this stage of the process, those innovations must be driven by concepts, not weapons or platforms.

The Services, and in some cases Defense Agencies, would offer proposed solutions to meet joint needs. Selection of the best alternatives must be preceded by appropriate planning and analysis, and conducted with sufficient transparency that all stakeholders accept the validity of the results. Analysis would be conducted by teams from OSD, the Joint Staff, and the Services, with CoCom representation to ensure that analysis reflects a realistic assessment of current and future warfighting concepts.

Ultimately, the choice of alternatives to fulfill key joint needs is the responsibility of the Secretary of Defense. Those decisions must be supported with independent military advice and with full recognition of their costs, benefits, and opportunity costs.

The Secretary of Defense's decisions would be used to update a set of rolling capabilities plans that outline current and future capabilities, anticipated schedules, performance metrics, and estimated costs. Annual Joint Programming Guidance (JPG) would solidify the decisions made within a given year and subject the totality of the guidance to a fiscal adequacy test to ensure that the Services and Defense Agencies have sufficient resources to comply with the guidance. This process would force all stakeholders to confront inevitable tradeoffs, and to prioritize their needs. The result would be an agreed-upon statement of defense needs and a realistic business plan for meeting those needs within available resources.

Finally, DoD's annual performance review process must focus on how the investments made in the preceding year's budget addressed the strategic priorities in the SPG and the capabilities directed by the JPG.

The following discussion outlines the attributes of the proposed process in greater detail.

A New Framework—Joint Capability Categories

To support needs definition, gap and excess analysis, major trade analyses, and capabilities planning, DoD's capabilities must be divided into manageable groups, or capability categories. The defining of joint capability categories is an essential early step to implementing a capabilities-based approach because they would provide the framework for capabilities planning, for comparing Service contributions to joint warfighting and enterprise support, and for facilitating cross-Service trades.

Capability categories can be created along functional or operational lines. Functional capability categories would be useful because there are relatively few of them, representing those activities or processes that must take place if the Department success-

fully pursued its military activities. The Joint Staff has created five—force application, protection, logistics, command and control, and battle-space awareness—all focused on warfighting needs. To address enterprise needs, the Department may need to add more categories such as force management and infrastructure.

Alternatively, joint capability categories can be built along operational lines (i.e., military activities). Examples of these categories include denying sanctuary to the adversary, ensuring freedom of navigation, and denying adversary access to space.

The functional categories would be more enduring of the two types—they are less apt to change because of new technologies, emerging threats, or doctrine updates, so they may be a more appropriate basis for organizational changes. They also offer clearer boundaries to assign weapon systems and platforms, thereby reducing redundant assignment of platforms to categories, which would further improve the ability of functional capability managers to develop and implement capabilities planning.

In contrast, operational categories provide a direct link to the CoComs and would support major trade analysis by military operation.

Whether organized along functional or operational lines, the new categories must enable all Services, Defense Agencies, and CoComs to focus their planning on capabilities. If the right categories are created, strategic guidance, analytical capabilities, and programs and budgets could also be organized around them. Figure 2-4 depicts how capability categories could be used as an organizing construct for both information and analytical activities across the entire process.

Figure 2-4. Capability Categories

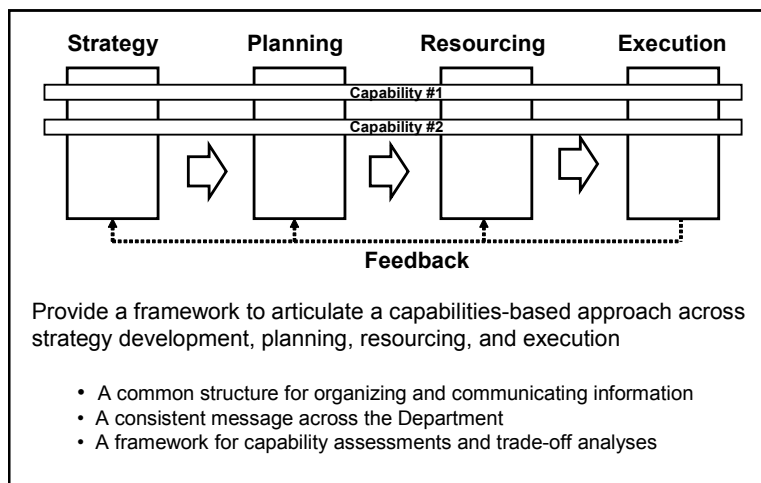

Senior Oversight—The Strategic Planning Council

Since it expends enormous resources in support of the national strategy, DoD must maintain a clear linkage between that strategy and how the resources are

used. A Strategic Planning Council (SPC) would provide senior leaders with a venue to offer formal inputs to shape defense strategy and support effective oversight throughout the end-to-end process of strategy development, capabilities planning, resourcing, and execution. Members of the SPC would set the direction of the Department and assess whether the process is moving in that direction.

Chaired by the Secretary of Defense, the SPC would be comprised of the Deputy Secretary of Defense, the Under Secretaries, the CJCS, the Service Secretaries and Service Chiefs, and the CoComs. It would meet three times per year, or more frequently at the discretion of the Secretary of Defense.

Top-Down Strategy Development

The Department of Defense's support for national strategy should reflect the judgment of its most senior leaders. The SPC would provide the forum in which the CoComs could air their views on the challenges they face and shape the strategy to meet their near- and long-term challenges. Those views would become the "top-down" input to the strategy development process. The CoComs' staffs would need to shoulder increased responsibility for identifying issues and coordinating closely with the Joint Staff to ensure that the strategy meets the demands of their theaters. The lower-level working groups and committees that actually draft strategic planning guidance would need to ensure that the explicit inputs of the SPC are incorporated.

The SPG should be a single, unified, fiscally-informed document covering both warfighting and enterprise capabilities. It also should do the following:

- ◆ *Establish strategic objectives and priorities.* The SPG should include a view of the near- and far-term strategic environment and objectives to support national strategy. It also should address force sizing and employment concepts, desired response times, assumptions, and priorities by theater and mission area.
- ◆ *Identify fiscal and other planning constraints.* The SPG should identify the planning assumptions used in developing the Department's top-line funding, as well as other factors such as personnel increases or reductions. Although detailed costing is not possible at this stage, the intent would be to avoid a "two MTW strategy with a one MTW top line." Other planning constraints, such as ongoing operations, should be stated as well.
- ◆ *Articulate priorities and risk tolerance.* The Secretary of Defense should use this section to formally state priorities for the Department and to define the acceptable level of risk within capability categories, theaters of operation, and the four Quadrennial Defense Review risk categories (operational risk, future risk, institutional risk, and force management risk).

-
- ◆ *Establish joint capability objectives.* The SPG should identify the joint capability objectives defined in prior-year planning and studies. These objectives should be framed in effects-based terms that do not preclude any potential alternatives, and where possible, include metrics and scenarios. Force providers would use this guidance to develop and evaluate alternative capabilities.
 - ◆ *Identify strategic concepts for planning future enterprise functions.* The SPG should clearly identify the strategic goals for the Department's work force, infrastructure, "overhead" support, and acquisition, which would ensure that enterprise activities are fully integrated with warfighting plans.
 - ◆ *Identify future joint operational and organizing concepts.* The SPG should assign experimentation, science and technology, and capability priorities to enable new operating concepts.

The SPG may direct studies as necessary to identify issues for future consideration in the planning process. Normally, the SPG would not provide programmatic guidance, but instead provide unified direction to the Department's joint planning efforts, which in turn would produce the programmatic direction intended to support defense strategy. The intent of the SPG would be to *begin* the Department's planning process by providing strategic direction rather than *end* the process with specific programmatic guidance.

Capabilities Planning—Enhanced Planning Process

The Enhanced Planning Process is designed to link strategy to program development by assessing current capabilities, analyzing gaps and excesses, and recommending alternatives for the SecDef's decisions. These decisions are captured in a rolling capabilities plan and are then disseminated for action through the annual JPG.

The rolling capabilities plan is not envisioned as a published document, but would serve as a repository of capabilities decisions made throughout the year. It would be a management tool (potentially web based) that communicates to the Department current and future capabilities, gaps and excesses, and the associated efforts to address those gaps and excesses. It would also provide a forum for sharing information about anticipated schedules, performance metrics, and estimated costs of joint programs and about experimentation, technology development, and lessons learned. Rolling capabilities plans would be developed for each joint capability category.

Key joint stakeholders, such as the CoComs, would need to participate extensively in the process to ensure that solutions are "born joint." A competitive process would develop alternative solutions to achieve the needed joint warfighting capabilities. Services and Defense Agencies would be responsible for developing innovative alternatives to achieve the desired capability.

The alternatives would typically be developed as end-to-end solutions using various approaches. The alternatives would be evaluated in an open and collaborative analytical process, based on their overall contribution to joint operational capabilities. This would allow the Department to decide “how much is enough” in a given capability area, and could result in cross-Service trades or trades among major capability areas.

Figure 2-5 describes the Enhanced Planning Process in simplified terms. At the heart of the process is a comparison of current capabilities with those needed to perform tasks and missions. Scenarios and concepts give context to the tasks and missions. The disconnects can be characterized as capability gaps (implying that tasks or missions cannot be accomplished with existing capabilities) or capability excesses (unnecessary redundancy exists or a specific capability is no longer needed). This analysis would begin the process that shapes future capabilities.

The Enhanced Planning Process would receive input from two major domains: warfighting needs and enterprise needs. Warfighting needs are the resources needed to execute warfighting missions, while the enterprise needs cover areas such as infrastructure and the workforce. Combined, these needs reflect the spectrum of considerations—doctrine, organization, training, materiel, leadership, personnel, and facilities (DOTMLPF).

Figure 2-5. Simplified Capabilities Planning Process

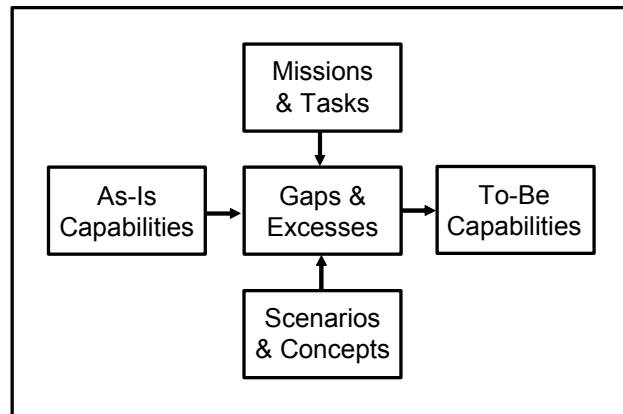

Because the Department has more needs than resources, it must seek the highest levels of efficiency and effectiveness, eliminate unnecessary duplication among Services, and develop multi-Service efficiencies. This capability requires an assessment of needs above the Service level.

Figure 2-6 shows the changed role of the Services in determining needs and choosing solutions to those needs. At the Department level, an analytical capability would define the joint needs and conduct cross-Service/Component analysis to satisfy those needs. This analytical activity, or analysis engine, must provide a collaborative environment that brings the views of the CoComs, Joint Staff, Defense Agencies, Services, and OSD into a single forum and integrates all aspects of capabilities planning.

Figure 2-6. New Roles and Responsibilities for Joint Needs

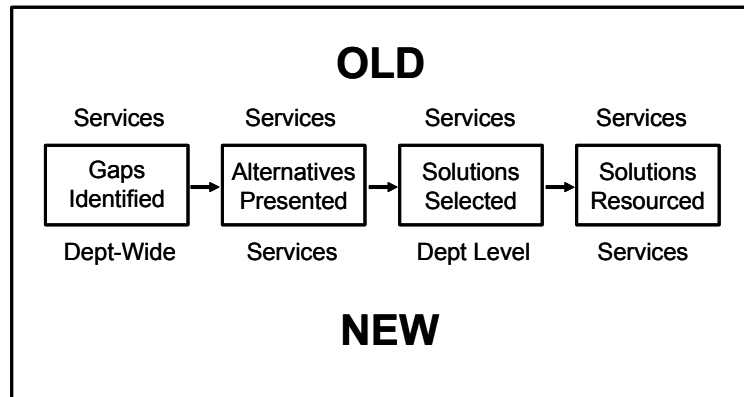

The analysis engine, the heart of the Enhanced Planning Process, would perform five key functions: defining joint needs, identifying gaps and excesses in current and future capabilities, conducting top-level trade analyses in capability terms, assessing alternatives that have been nominated by the Services to fill capability gaps, and prioritizing these actions to ensure that the most pressing issues are fully resourced.

To perform these functions, the analysis engine needs to do the following:

- ◆ Create and maintain the methodologies and tools required to conduct capabilities analysis at the Department level
- ◆ Articulate outcome-oriented joint needs from a Department rather than a Component view
- ◆ Identify current gaps and excesses by characterizing current capabilities with respect to assigned missions and tasks
- ◆ Identify future gaps and excesses by characterizing future capabilities with respect to operating concepts and projected missions and tasks
- ◆ Prioritize current and future gaps
- ◆ Assess the impact on capabilities of SPG, lessons learned, experimentation, technical opportunities, study recommendations, operating concepts, and emerging threats
- ◆ Assess proposed alternatives to fill gaps in capabilities
- ◆ Present decisions, particularly those concerning major trades, for senior leadership
- ◆ Create a “living” audit trail of capabilities decisions and associated rationale in a transparent rolling capabilities plan

- ◆ Translate joint capabilities decisions, where appropriate, into programatics for inclusion in the JPG.

The analysis engine would require substantial analytical support and warfighter assessment. At the Department level, the analytical capability does not exist to support all the activities listed above. Analytical support would need to be contracted or moved from other parts of the Department. (Federally Funded Research and Development Centers, or FFRDCs, are potential candidates for providing that support.) Warfighters and analysts would need to be brought together in a structured way to populate the analysis engine with the necessary expertise.

As shown in Figure 2-7, capability teams would provide a forum of expertise to accomplish the needed analytical support. These teams could be arrayed by capability category or by functional discipline. The goal would be to facilitate capabilities analysis and planning, ensuring that the range of warfighting and enterprise issues is addressed in the Enhanced Planning Process.

Figure 2-7. Department-Level Analysis Engine

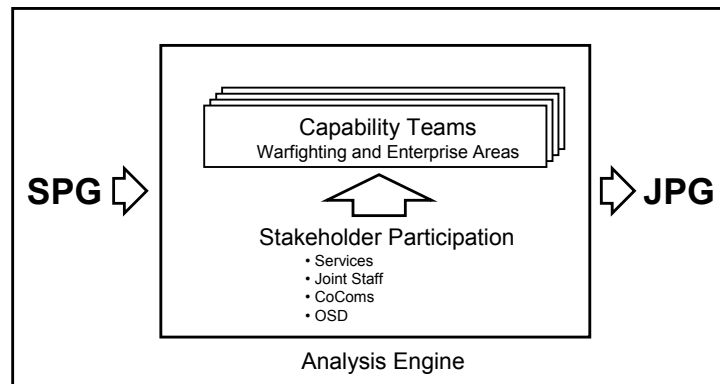

Improving the analytical capability at the Department-level through an analysis engine would help identify cross-Service interoperability issues and concerns. The analysis engine requires a counterpart activity, also at the Department-level, to assess interoperability needs and communicate the technical standards to resolve them. Systems engineering support would also be required, perhaps at U.S. Joint Forces Command or OSD, to provide interoperability standards and harmonize net-centric and command and control needs across the joint community.

The activities within the analysis engine occur throughout the year. The teams would review study results, experimentation, lessons learned, threat changes, technology opportunities, and capability needs documents to identify areas that could affect the capabilities for which they provide analytical support. These efforts would be included in each team’s rolling capabilities plan. Once a year, these decisions would be captured in the fiscally constrained JPG and disseminated to the Department.

Figure 2-8 summarizes the process that would occur inside the analysis engine. This process is designed to capture the joint warfighting and enterprise needs of the Department.

Figure 2-8. Analysis Engine Activities

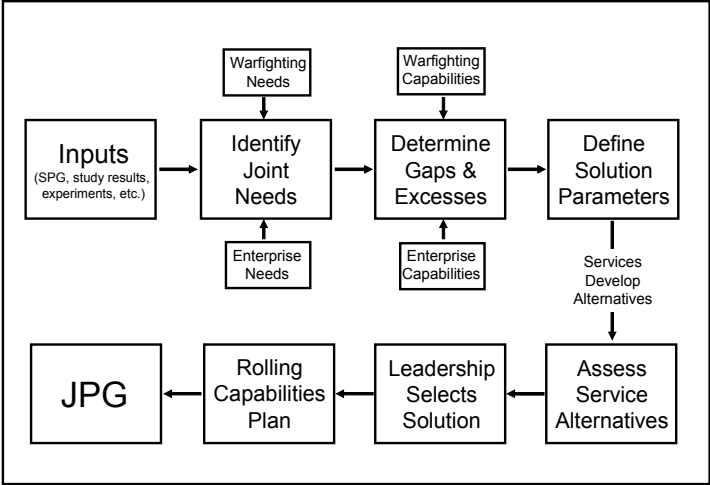

The process would address issues that fall within a single capability category or cross capability categories. Cross-cutting issues would require ad hoc teams (or “tiger teams”) to be formed from the analysis engine to assess the specific problem and present decision opportunities for senior leadership. Examples of cross-cutting issues include determining global presence, operational availability, and active and reserve component mix. The results would then be passed to the capability teams for integration into capabilities planning for their area of responsibility and ultimately translated into programmatic guidance.

To develop the JPG, the analysis engine would need to prioritize and integrate needs and solutions, and ensure that all doctrine, organization, training, materiel, leadership, personnel, and facilities considerations are addressed. Therefore, a forum must exist to harmonize recommendations and decisions before they are incorporated into the rolling capabilities plans. These recommendations and decisions would be accumulated throughout the year, and when viewed in totality for inclusion in the JPG, some may not be affordable and set aside. Determining the decisions that should be resourced will be difficult, but setting priorities at the front end should improve the process. Figure 2-9 illustrates the idea.

Figure 2-9. Major Trades and Integration

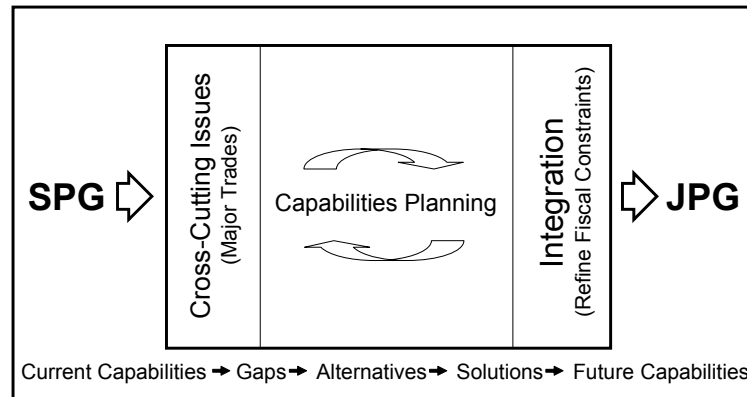

Many of the skill sets needed to populate the analysis engine are resident in the Joint Staff and OSD. They are essentially a hybrid of today’s program review issue teams and the Functional Capabilities Boards. The issue teams have been very successful in solving problems by carefully framing each issue, representing all views, and presenting alternatives for leadership selection.

The Functional Capabilities Boards have created a collaborative environment to vet disparate views and provide a capabilities management function that develops and maintains methodologies, metrics, and assumptions needed for analysis. Bringing both skill sets together would create a powerful analytical capability.

After the analysis engine has a recommendation ready for decision, it would forward the recommendation to a mid-level review board and then to a senior decision body (see Figure 2-10). Recommendations would be submitted in the form of alternatives, with pros and cons, rather than a single solution. To the maximum extent possible, senior leaders would be given the opportunity to choose from viable and distinct alternatives.

Figure 2-10. Capabilities Decision Process

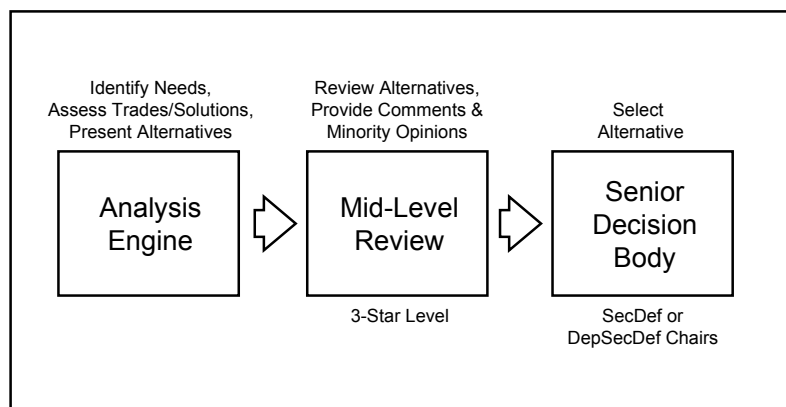

The mid-level review body would consist of 3-star equivalents from the Services, Joint Staff, OSD, and Defense Agency stakeholders. (CoComs may seek opportunities to attend, but because this body meets weekly their attendance may not be practical without an expanded presence in the Pentagon.) This body would review all alternatives forwarded by the analysis engine and then send all comments and recommendations, *including minority opinions*, to the senior decision body.

The senior decision body—currently the Senior Leadership Review Group—would be chaired by the Secretary or Deputy Secretary of Defense and consist of senior representatives from the Services, Joint Staff, OSD, CoComs (to the extent practical), and applicable Defense Agencies. This body, which would meet less frequently than the mid-level review body, would focus on selecting alternatives and resolving major or contentious issues. To the extent agreeable to the stakeholders, the senior decision body may return some decisions—such as approval for concepts, study assumptions, metrics, methods, and capability plans—to the mid-level review body.

“Born Joint” Resourcing Process

Decisions from the Department’s leadership would be captured during the year and then incorporated in the annual JPG. The JPG is a fiscally constrained business plan that addresses the totality of the defense budget, describes the capability needs that were collaboratively developed during the Enhanced Planning Process, and identifies the means for meeting those needs. It also communicates specific programmatic actions on issues of concern to the Secretary of Defense and the joint capability resourcing needs stemming from the Enhanced Planning Process. Output-based metrics would be provided to ensure that the capability needs of the joint community are met. The SPC would review the JPG prior to signature to ensure compliance with the top-down guidance contained in the SPG. The JPG would also do the following:

- ◆ *Comply with the Strategic Planning Guidance.* The JPG would address the extent to which the program guidance complies with the priorities, strategic objectives, and risk tolerance conveyed in the SPG. Specific programatics contained in the JPG must clearly support the defense strategy.
- ◆ *Provide directive guidance on selected joint capability issues.* Programmatic guidance would be provided in a format similar to a Program Decision Memorandum. Components are required to incorporate directive guidance in their Program Objective Memorandums (POMs). Guidance in this section may also be used to correct or maintain prior-year decisions. Although this section of the JPG would be compulsory, it incorporates decisions made during the Enhanced Planning Process. The Components should not be surprised by the guidance contained in this section of the JPG because they have been full participants in the capabilities planning process.

- ◆ *Identify programmatic areas that are delegated to the Components.* The vast majority of the defense program would be delegated to the Components. Within the delegated guidance areas, the SecDef may elect to identify goals, objectives, or measures of effectiveness on resource allocation. For example, the SecDef may require that a certain percentage of the budget be dedicated to a specific program area such as science and technology. These metrics would be designed to coordinate the Department's resourcing efforts, while not being overly prescriptive of Service responsibilities.
- ◆ *Ensure fiscal adequacy.* All guidance, directed and delegated, must be fiscally executable. This portion of the JPG would demonstrate that the Components have not been given more guidance than they can resource.

With clear and fiscally constrained guidance in the JPG, the Services and Defense Agencies would be given information to build POMs that are in the best, overall interest of the Department. Ultimately, this practice should result in a less contentious program review process, particularly because the Services and Defense Agencies would only be given programmatic guidance that has already incorporated joint needs. Building in "bill payers" or "salami slicing" programs to support joint programs added late in the process should no longer be required.

The program review would focus primarily on ensuring JPG compliance and addressing fact-of-life issues and unforeseen events. The CoComs would need to participate in the program review to assess the impact of fact-of-life changes. A mechanism similar to a Program Change Proposal or issue paper may be required to accommodate these views.

To further streamline the resourcing process, program and budget reviews should be accomplished simultaneously. Doing so would shorten the amount of time between POM submission and the President's Budget. Eventually, as the Enhanced Planning Process matures, it may be feasible to delay POM submission until late September or early October. The later these documents can be submitted, the greater the likelihood that the Department would be able to incorporate emerging fact-of-life changes.

Improved Assessment and Feedback Process

This portion of the process focuses on assessing how well the Department did what it set out to do. The "providers," primarily the Services, would report on "what they actually got" for the resources provided. The "users," led by the CoComs, would report on whether they were able to perform their missions with the capabilities provided and whether those capabilities were sufficient to execute the strategy. The results of the assessment would be presented to the SPC for discussion, used as a mechanism to develop subsequent planning guidance, and

transmitted once a year to Congress as part of the Secretary's *Annual Report to the Congress*.

Assessments would be prepared by an independent office, possibly supported by a small staff. The role of the assessor would be to:

- ◆ Integrate assessments of current capabilities provided by the CoComs, Joint Staff, Service Chiefs, Principal Staff Assistants, Agency Heads, and team leaders in the Enhanced Planning Process.
- ◆ Assess whether the capabilities were delivered as expected and as directed in the JPG (in both delegated and directive sections).
- ◆ Determine whether total capabilities were sufficient to meet the strategy as a whole.

The performance assessment process would take two forms: periodic briefings and a written annual report. Both would address warfighting and enterprise activities and be organized around the capabilities categories and objectives outlined in the SPG and JPG.

The primary audience for the periodic briefings on program execution would be the SPC. These briefings would be based on capability metrics defined in the Enhanced Planning Process. The annual performance assessment report, intended for both internal and external audiences, would summarize overall performance and relate it to the Department's goals. It would be at a high level of aggregation and use a Balanced Scorecard framework. After full transition to the new process, the report would become the basis of the *Annual Report to the Congress*.

Process Timeline

Figure 2-11 provides an overview of the major activities of this process. The process would begin with a spring SPC meeting to develop top-down guidance for the SPG to be released in the fall. The top-down guidance would be based on feedback from the previous cycle and issues developed by the SPC members. In the fall, the SPC would review the draft SPG to ensure that top-down guidance was incorporated.

Figure 2-11. Activity Calendar

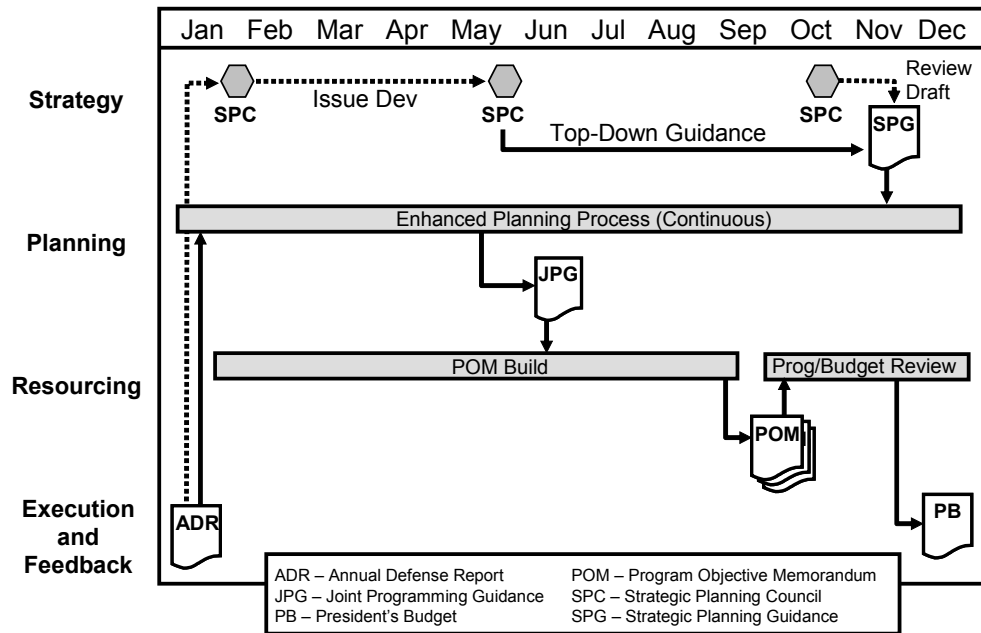

SPG-directed issues and studies then enter the Enhanced Planning Process. Decisions from the Enhanced Planning Process would be captured in rolling capabilities plans and then articulated in the annual JPG. The SPC, in its spring meeting, would review the draft JPG to ensure compliance with the SPG. The Services would incorporate the JPG into their POMs, which are submitted in the fall.

Program and budget reviews would be accomplished simultaneously with a budget submitted to the Congress in January. Budget execution would occur during the next fiscal year. After execution, an assessment would be provided to the winter SPC on how well the Department acquired desired capabilities to meet the defense strategy. Feedback would be used to influence the next SPG, and the process repeats.

One of the key concerns in this process is balancing workloads throughout the year. Care must be taken not to overburden the system, particularly during program and budget reviews when the SPG would be published.

Chapter 3

Organizational Alternatives

The Study Team identified two levels of organizational alternatives that address the structural changes needed to implement the new capabilities-based process. First-order organizational alternatives address the changes needed at the Department/corporate level to support capability-based planning. The second-order organizational alternatives address changes within major enterprise functions (such as acquisition and logistics) to accomplish the end state planning and execution processes. For both levels, the Study Team developed a set of moderate, aggressive, and radical alternatives, based on the extent of the needed change.

DEPARTMENT/CORPORATE LEVEL (FIRST-ORDER ALTERNATIVES)

The Study Team developed detailed recommendations for each of the processes within the four major end state phases: strategy, enhanced planning, resourcing, and execution and accountability. The Team then assessed whether organizational change was needed to better identify joint needs and deliver the capabilities to satisfy those needs, in accordance with the end state processes. The Team concluded that organizational changes were not needed to support the proposed process changes to the strategy and resourcing phases, but changes are required to achieve the end state in the other phases. Figure 3-1 illustrates this distinction.

The Enhanced Planning Process would require a Department-level organization capable of identifying gaps and excesses, and leading DoD-wide trade analysis across warfighting and enterprise functions. The analytic function would comprise the “engine” around which the headquarters planning activities should form. The options presented in this section address alternative organizational structures for carrying out the functions of the analysis engine, while potentially reducing the total headquarters staffing.

Figure 3-1. Overall Process with Organizational Change Requirements

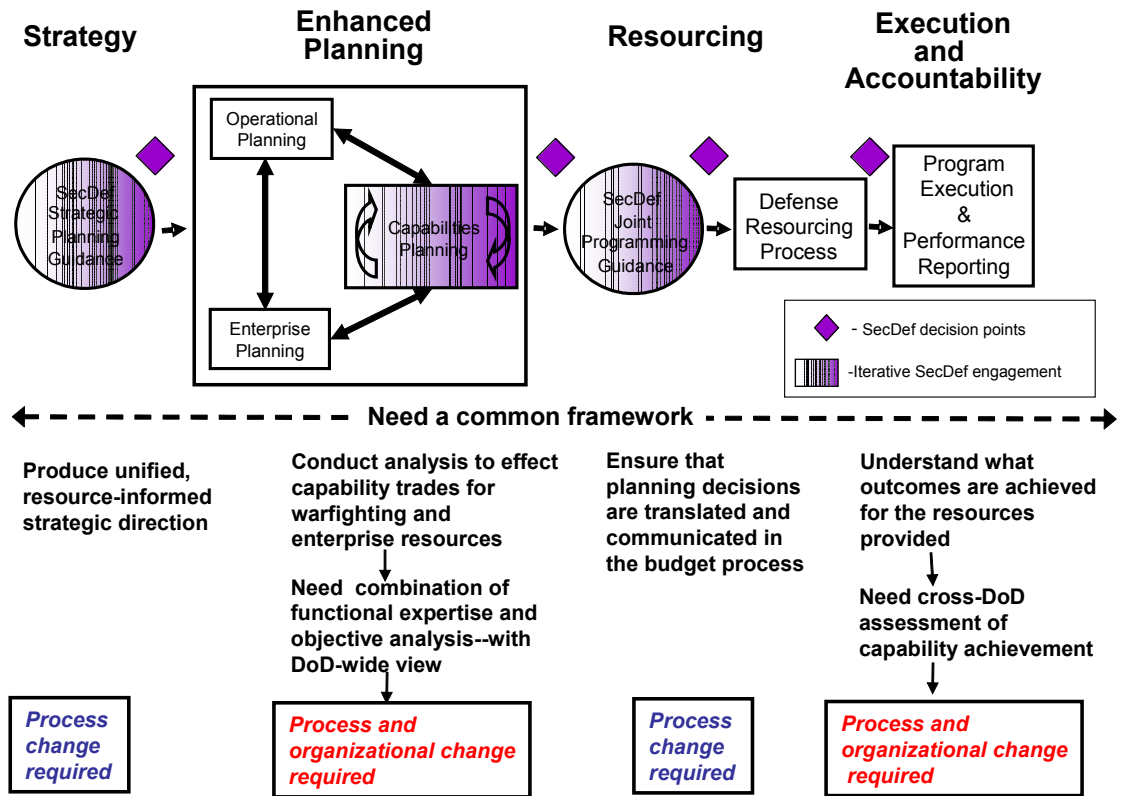

In addition to addressing Enhanced Planning Process (analysis engine) functions, the organizational options discussed below include proposed changes to accomplish the execution and accountability phase. The goal is to create the ability to perform independent assessments of the capabilities actually delivered and to formulate judgments about whether those capabilities met the strategic objectives.

These first-order organizational alternatives would not involve changes to the Services or the CoComs. However, in all of the options, the CoComs and Services would play a different role than in the current planning process:

- ◆ The CoComs would have an increased role in defining joint needs and priorities.
- ◆ The Services/Defense Agencies would focus on providing solutions to joint needs.

Although internal changes to accomplish these roles should be left to those organizations, both would be encouraged to align themselves to support the new end state. CoComs in particular may require an increased presence in the Pentagon to participate more fully in the new process.

The question that drives the alternative organizational options is how to most efficiently structure OSD and the Joint Staff to interact with the key stakeholders in leading the definition of needs and determining the right solutions to those needs. The following are other design criteria for the organizational alternatives:

- ◆ The roles of the SecDef and the CJCS would not change.
- ◆ Top-level needs, gaps, and excesses would be identified by an organization with a DoD-wide view.
- ◆ Both warfighting and enterprise areas would be considered
- ◆ The size of the headquarters staff would not increase.

Alternative 1: Enhance the Functional Capability Boards

The first alternative, depicted in Figure 3-2, leverages the current Joint Staff Functional Capability Board initiative to analyze warfighting capability needs and solutions using an ad hoc format with broad stakeholder participation. This alternative would build on that structure by expanding it to include enterprise functions. The OSD divisions with expertise in the enterprise functions could sponsor the additional Functional Capability Boards. These boards would be co-chaired by the Joint Staff and OSD.

Figure 3-2. Alternative 1—Moderate Change

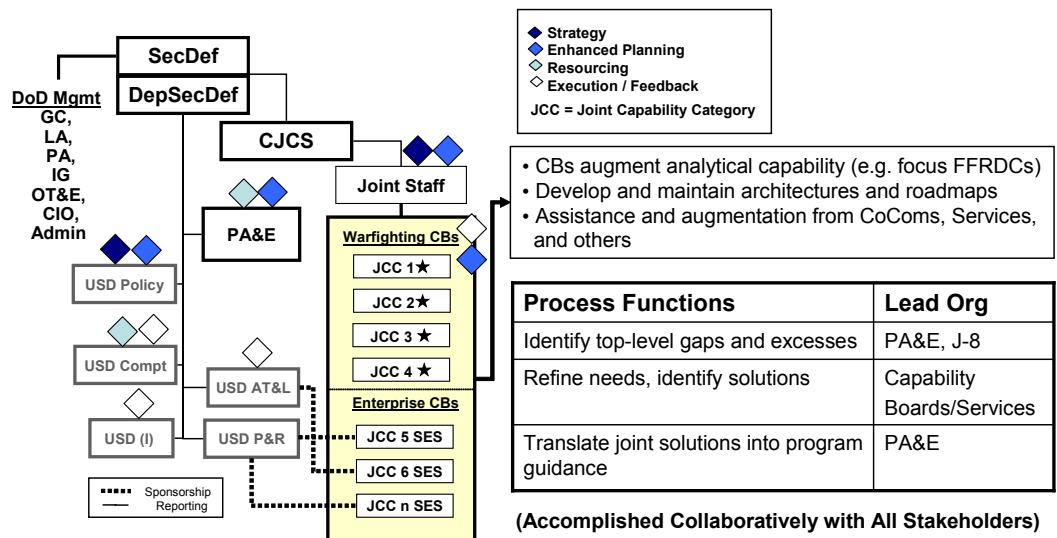

To enable the Functional Capability Boards to accomplish their objectives, they should have dedicated analytical tools, provided by redirecting the efforts of current Department analysis centers, refocusing the efforts of FFRDCs, or using other contracted analytical expertise. The CoComs and Service staffs would be

required to provide additional subject matter expertise to these capability boards. In this organization, the Director, Program Analysis and Evaluation (DPA&E), working with J-8, would perform the analysis scoping function that identifies top-level gaps and excesses. It would also integrate the output of the analysis engine and translate it into programming guidance.

DPA&E would lead the execution and accountability process, and the CoComs and Joint Staff would perform the assessments of military and operational capabilities. The Services would execute the programs, and provide feedback through their existing reporting processes.

This alternative would rely on issue teams to analyze and assess joint capability needs to inform programming decisions. This alternative would use ad hoc team members, drawn from organizations with an equity stake in the outcomes. Without a formal reporting structure, this option would be relatively more reliant on leadership personalities to achieve corporate-level joint planning.

Alternative 2: Establish a Corporate Planning Staff

This alternative, shown in Figure 3-3, is an aggressive change that moves away from the ad hoc nature of the joint planning organization. It would merge existing staff elements into a Joint Capability Planning organization under the direction of a Principal Staff Assistant for Capability Planning—PSA(CP). It would include most of the other principal assistants on the OSD staff and be the single Department headquarters entity performing capability planning. It would serve both the CJCS and SecDef. This organization would be formed by dual-hatting personnel from the Joint Staff (primarily J-8) and merging them with elements of the current PA&E and potentially other OSD organizations. The DJ-8 on the Joint Staff would be dual-hatted as the Deputy Director for Capability Planning to provide senior warfighting expertise and a direct reporting path to CJCS. Service and Co-Com participation would be the same as for Alternative 1.

This alternative would add an independent performance assessment division that reports directly to the Secretary. The division would lead the execution and accountability phase of the process. It would be small, formed from elements of other OSD divisions, and draw on information provided by the Services, Agencies, CoComs and Joint Staff.

A separate capability planning division would combine operational and analytic expertise from both warfighting and enterprise functions into a single, corporate-level organization. This organization would have the skills needed to conduct Department-wide analyses and capability planning, with the participation of the Components and the CoComs. It would also consolidate and integrate analyses to support corporate-level decision-making. This alternative enhances the CJCS's role. Although the alternative recommends a realignment of Joint Staff resources, the Chairman would gain access to an expanded analytic capability, with a view

of enterprise and other Department-level issues. Initially, some organizational turbulence would be associated with the staff migration.

Figure 3-3. Alternative 2—Aggressive Change

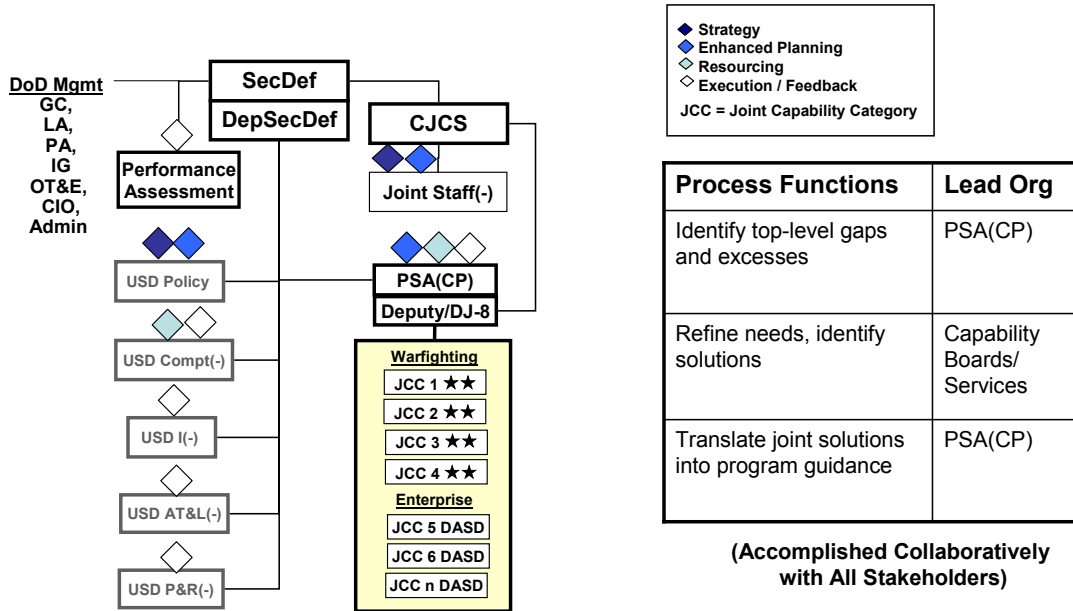

Alternative 3: Streamline the Executive Staff

This alternative, shown in Figure 3-4, would provide a completely revised and streamlined Executive Staff organized around the principal tasks and implementing functions for Department headquarters. The number of Under Secretaries of Defense would be reduced to four and charged with overseeing the planning and military operations tasks, and the resourcing and enterprise implementation functions. The Executive Staff would be formed and streamlined by merging large portions of the current Joint and OSD staffs, with the option of using CoCom representatives to form the core of the Operations Staff. Current redundant staff functions would be reduced by having military members of the Executive Staff dual-hatted to serve both the SecDef and CJCS. Military Deputies to the PSAs would provide the direct reporting path to the CJCS. The CJCS would retain a smaller joint staff, with dedicated support in areas directly related to operational planning and execution. The capability planning staff in this alternative would have the responsibility for capability analysis and integration, as it would in Alternative 2.

This alternative would reduce the overlap of functions between OSD and the Joint Staff. The OSD staff would focus on policy and oversight functions, while the Joint Staff would concentrate on military planning and operational issues. This reduction in duplication could result in a smaller staff for the OSD and Joint Staff. The interaction needed to manage cross-cutting issues would be achieved through increased use of matrix management and issue-oriented teams. Within this alternative is the option to change the role of the Vice Chairman of the Joint Chiefs of

Staff to include serving as the Operations Director. Title 10 changes may be required if this option is pursued.

Figure 3-4. Alternative 3—Radical Change

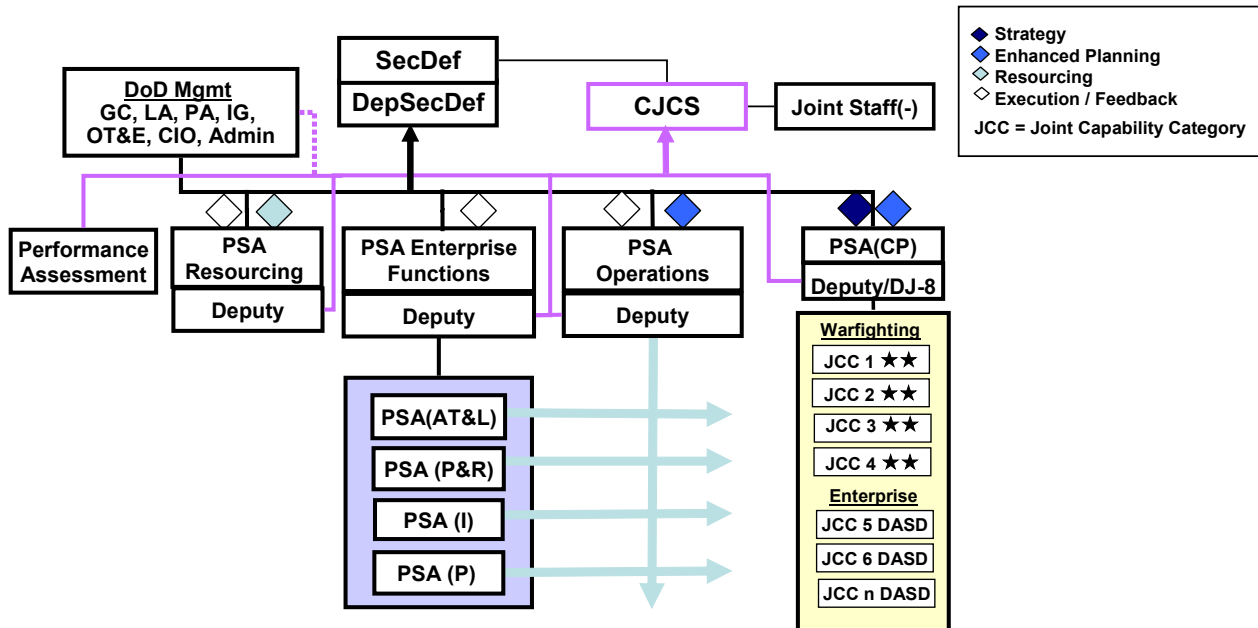

Like Alternative 2, this alternative includes an independent performance assessment division to lead the execution and accountability phase of the process. This organization would be small, formed from elements of other OSD divisions, and report directly to the Secretary of Defense and CJCS.

This radical change alternative would provide the analytical capability needed to execute the end state process, have the greatest potential to significantly reduce the total headquarters staff, and allow for greater integration of the operations tasks with the implementation and oversight functions. At the same time, this alternative has implementation risks: it could require Congressional approval in areas pertinent to Title 10 (especially dealing with the “independent” nature of the support to CJCS for his military advice responsibility), and it involves significant staff migration and realignment. The dual-hatted nature of the staff and reporting paths from the military deputies to the CJCS are designed to meet the Chairman’s military advice responsibilities. Properly effecting the realignment would require regular leadership involvement and oversight.

FUNCTIONAL LEVEL (SECOND-ORDER ALTERNATIVES)

A large percentage of DoD's resources is devoted to enterprise operations. Those operations encompass a wide range of necessary and vital support functions, such as acquisition, facilities management, and recruiting, that enable the Department to prepare for, deploy to, execute, sustain, and rapidly recover from its military operations. The Department's investment in enterprise operations, and the resulting capabilities, must be accounted for in a comprehensive and fiscally disciplined SPG, Enhanced Planning Process, and JPG.

Currently, the assessment and management of the Department's enterprise capabilities are decentralized among OSD, the Services, and other Component leaders, with varying goals, time horizons, and risk strategies. Many of the issues within the functional elements of enterprise operations are often addressed "after the fact," and critical decisions on major warfighting capabilities are often made without full consideration of the enterprise implications.

The Enhanced Planning Process calls for a comprehensive assessment of all Departmental capabilities, including the enterprise functions. In this effort, the Study Team focused on five key functions: acquisition; research, development, test, and evaluation (RDT&E); logistics; infrastructure; and workforce planning. Under the existing organizational structures, a comprehensive assessment under the Enhanced Planning Process would be difficult and inefficient because enterprise responsibilities, information, funding, and overall control are dispersed throughout the Department and resident in multiple Components.

The five functional elements addressed by the Study Team are important to both the planning and the execution and accountability phases. It is imperative to have an established means to monitor the results in these areas against the desired (funded) capabilities and validated joint needs. The following subsections discuss some of the organizational changes needed to improve the visibility of those enterprise operations at the Department level, assess alternative strategies for supporting joint needs, and provide necessary feedback on program execution to Department leaders. Each alternative is consistent with the broader first-order organizational alternatives.

Acquisition

The current acquisition process is largely Service-based and lacks a direct link between identifying, programming, and delivering needed joint capabilities. Recent changes are beginning to shift the focus to a capabilities-based approach to identifying requirements. These changes are designed to streamline a rigid, event-driven, and lengthy process. But even with the recent changes, the acquisition planning process separates the customers, particularly the CoComs, from acquisition decision makers. Other shortfalls, such as an inability to capture life-cycle

and support costs during planning, as well as the difficulty in canceling programs that are not cost-effective, hinder the Department's joint capability-based process.

The following alternatives would leverage the ongoing changes within the Department's acquisition community and provide organizational constructs to facilitate the planning, development, and delivery of needed joint and Service capabilities. Each alternative attempts to provide a more effective means to establish continuous customer-user engagement in the planning process.

ALTERNATIVE 1: MULTIPLE JOINT PROGRAM EXECUTIVES

The moderate alternative to the current acquisition process entails establishing a Joint Program Executive (JPE) for each of the functional capability categories, reporting through the Service Acquisition Executives (SAEs). The JPEs would work within their Component's corporate-decision structure to provide input on current joint in-development, in-production, and legacy programs. They would manage resources for their specific programs provided by the Components, as stipulated in the JPG, and they would participate in the enhanced planning process. The Defense Acquisition Executive Summary (DAES) would be transformed into a virtual, cross-Service process to allow for Department-wide management across capability categories. This DAES transformation would permit the establishment of a cross-cutting Defense Acquisition Board (DAB) organized by capability category.

This alternative has several additional features:

- ◆ JPEs would provide input to the Defense Acquisition Executive (DAE)—USD(AT&L)—on current programs, linking the acquisition process to joint needs planning and development.
- ◆ JPEs would oversee resources allocated from the Components' total obligation authority to support directed joint programs (JPG-directed guidance) to ensure compliance with the JPG. SAEs would retain resource control for Service programs under the delegated guidance within the JPG.
- ◆ DAE, with JPE and SAE input, would develop a comprehensive acquisition strategy that leverages the JCIDS process to clearly articulate goals and objectives to meet departmental joint capability needs. A comprehensive acquisition strategy would allow for immediate, near- and long-term programmatic planning to meet joint capability needs.

The major advantage of this alternative is that it would provide increased interoperability and better materiel solutions because it focuses on capabilities rather than on platforms. In addition, the defining, planning, and delivering of joint capabilities would be improved with increased connectivity between “requires” and “acquires.”

ALTERNATIVE 2: SINGLE JOINT ACQUISITION EXECUTIVE

The aggressive acquisition alternative would establish a single Joint Acquisition Executive (JAE) with oversight and decision authority on all joint developmental, in-production, and legacy programs. This authority would include management of all funds appropriated for joint programs. The JAE would be supported by expanding the responsibilities of a selected acquisition agency. Portions of selected Component organizations would need to be migrated into this entity. As with the moderate alternative, the JAE would participate in the Enhanced Planning Process by providing input on the development of a comprehensive acquisition strategy. The corporate decision structure would be transformed along capability categories to allow the JAE to manage cross-cutting joint capabilities within individual programs, while the overall program is managed by a Component.

Some of the additional features of this alternative include:

- ◆ JAE and SAEs, through the cross-cutting DAB, would provide input to the DAE on current joint in-development, in-production, and legacy programs. This approach would establish a direct link between central oversight and the acquisition process for joint needs planning and development.
- ◆ Appropriate portions of the Components' staffs—Services and Agencies such as the Defense Contract Management Agency, Defense Information Systems Agency, and Defense Logistics Agency (DLA)—would be migrated into an entity that acts as the JAE field activity.
- ◆ As with the moderate alternative, the JAE would participate in the development of a comprehensive acquisition strategy, and the DAB would be transformed along capability categories to align cross-cutting joint capabilities.

A significant advantage of this alternative is that it would create, from within an existing organization, an execution arm for joint capabilities, with a field activity to manage joint programs. It also would provide improved planning, greater coordination, and more efficient means to deliver joint capabilities. However, this alternative could result in a loss of authority by some Components and be seen as usurping some of the Services' Title 10 authority.

ALTERNATIVE 3: MULTIPLE CAPABILITIES ACQUISITION EXECUTIVES

The radical acquisition alternative would establish Capability Acquisition Executives (CAEs) for each of the joint capability categories. The CAEs would have oversight and decision authority on all defense developmental, in-production, and legacy programs. The overall acquisition process, management, and structure would be realigned by capability category. The CAEs would control all acquisition resources for their respective capability categories. The Services would estab-

lish Service Program Executive Offices (SPEOs) to manage their unique ACAT I and II programs. The SPEOs would report to CAEs on all programmatic issues. The CAEs would be directly involved in the development of a comprehensive acquisition strategy to meet Department capability needs.

This alternative also includes the following:

- ◆ The CAEs would reside in a dedicated joint entity (agency or field activity) developed to support this concept and organized from existing acquisition agencies.
- ◆ The comprehensive acquisition strategy would leverage JCIDS and Service-unique requirements to clearly articulate goals and objectives to meet Department-wide capability needs.

The advantages to this alternative are similar to those of the aggressive alternative. However, the establishment of the CAEs would remove control of program development from the Services, which clearly has Title 10 implications. In addition, completely realigning the current acquisition structure to support a capability-based approach would be a significant undertaking.

RDT&E

The Department's RDT&E resources and infrastructure are decentralized across the Components. In fast-moving technology areas, this decentralized approach to planning, programming, and execution results in inefficiencies, duplications, missed opportunities, and the inability to mass critical expertise in emerging areas. Currently, several AT&L offices and the Director, Operational Test and Evaluation monitor Component RDT&E programs within the Department, but they have limited ability to effect major transformational efforts.

The following alternative management structures would provide for more effective and efficient end-to-end planning and execution of the Department's RDT&E investment. These alternatives support the Enhanced Planning Process and are intended to result in an RDT&E management structure that optimizes Department resources.

ALTERNATIVE 1: COORDINATED INVESTMENT

The moderate approach to RDT&E reform would be to take advantage of initiatives already underway. The Department is required by law to develop a single performance review process, applicable to all Military Departments, for rating the quality and relevance of the work performed by DoD labs. The first step in this proposal would be to evaluate the recommendations from the studies directed by Section 913 of the FY 2000 National Defense Authorization Act. The intent is to more closely link technology development to the acquisition process and to the CoComs' joint needs. A second step would be to formalize the technology transition process, including binding agreements between Science and Technology

(S&T) sources and specific program offices. Funding managed by the Director Defense Research and Engineering (DDR&E) to support the transition of technology development efforts—such as the Advanced Concept Technology Development programs—would reduce the likelihood of “orphaned” technologies.

The development of a comprehensive DoD S&T strategy that is capability based but Component driven would be a significant improvement over current practices. Additionally, this alternative would provide for a better transition of technology from S&T to acquisition and improved utilization of the S&T and T&E investments through a single review process, with no changes in current legislation.

ALTERNATIVE 2: CENTRALIZED FUNDING AND CENTERS OF EXCELLENCE

A more aggressive approach to RDT&E reform would be to centrally manage resources in an Integrated Process Team (IPT) process. The Joint and Service Acquisition Executives, who control R&D resources, would work with the Defense Technology Executive (DTE), who controls S&T resources, to provide innovative capability solutions through representation on each of the capability teams. In addition, this alternative would include those activities described in the moderate alternative. Centers of Excellence (COEs) would be established within the current DoD/Service lab resources (including the universities doing basic research) to concentrate S&T and R&D efforts in specific areas. Although specialized, COEs could invest in several areas to provide competition for “best-of-breed” selection. They could do both S&T work for the DTE and R&D work for the JAEs and SAEs. The COEs would be challenged to present proposals for different governance options such as federal corporations or government-owned, contractor-operated (GOCO) entities that are more conducive to broadening the business base.

As with the moderate alternative, this alternative would provide for the development of a comprehensive DoD S&T strategy that would be capability based and centrally managed, while optimizing the S&T investment and reducing duplication through a single review and allocation process. The transition of technology from S&T to acquisition would be accomplished through an IPT process linking capabilities, technology, and acquisition. One disadvantage of this aggressive approach would be the dichotomy of centrally funding S&T programs while leaving labs and R&D centers the responsibility of the Components.

ALTERNATIVE 3: CENTRAL DOD LAB SYSTEM

A radical approach to RDT&E reform would be to centrally manage all resources between the CAEs and DTE in an IPT process. COEs would be established within a central lab system to concentrate S&T and R&D efforts in specific areas. Although specialized, COEs could invest in several areas to provide competition for “best-of-breed” selection. A single Office for Basic Research with a defense research lab would manage and execute all basic research for DoD.

A central DoD lab system would support a more comprehensive and coordinated DoD RDT&E strategy. The CAE and DAE would have the authority, resources, and infrastructure to better support DoD warfighting capabilities and the spiral development of technology uniquely designed to meet DoD capability needs. However, a complete realignment of RDT&E structure and the loss of Component control of RDT&E resources could pose a significant challenge. Legislative changes would be required to authorize a DoD Office of Basic Research, alternative governance charters for federal corporations and GOCO entities, and a change in reporting authority of DTE (DDR&E).

Logistics

Currently, no single logistics entity within the Department can provide the information and assessments needed to support capability planning, operations, and execution. The existing logistics responsibilities are a mixture of centralized and decentralized capabilities. No central planning function integrates the highly related logistics support functions of supply, maintenance, and transportation. In addition, current logistics planning reflects fragmented approaches among the acquisition process, Service and Defense Agency supply systems, and organic capabilities. Decentralized execution is needed at the operational and tactical levels. Nonetheless, strategic-level logistics planning, like operational planning, is needed to provide the comprehensive and interactive capabilities needed to best support joint operations.

The following alternatives present three options for managing the end-to-end planning and execution of the Department's logistics capabilities. These alternatives are consistent with the Enhanced Planning Process and maximize efficient use of Department resources.

ALTERNATIVE 1: STRENGTHENED DEFENSE LOGISTICS EXECUTIVE

This alternative would strengthen the role of the Defense Logistics Executive (DLE) as the single Logistics Global Supply Chain Manager with oversight and decision authority for defense materiel, maintenance, and visibility of movement. This alternative would not require major organizational changes because it simply expands the recently established duties of the USD(AT&L) as the DLE, by adding the responsibility for joint programs.

Under this alternative, the DLE, with the assistance of the Joint Logistics Board, would set policy for logistics (and logistics-related transportation matters) and would control funds for joint logistics efforts. The joint logistics efforts would include in-theater operations, Department-wide logistics programs, and organic repair and manufacturing. The DLE would also take the following actions:

- ◆ Establish a joint office for in-theater management in support of military operations.

- ◆ Manage the organizations that accomplish joint logistics programs.
- ◆ Oversee sustainment plans organized by joint capability missions, not by Service or Agency.
- ◆ Integrate sustainment planning and execution across the Department and focus them on warfighting support and readiness.
- ◆ Plan for efficiencies in operations, such as eliminating excess capacity in organic repair facilities.
- ◆ Engage and direct strategic, operational, and enhanced capabilities planning that addresses logistics and supply chain considerations and develop a strategic logistics plan with performance parameters. This plan would
 - articulate performance goals and provide a road map to meet them;
 - drive input to the operational plans development; and
 - provide a holistic view of departmental logistics requirements and how they support DoD needs.
- ◆ Be consistent with guidance stipulated in SPG.
- ◆ Leverage best practices and processes used by DoD, coalition partners, and industry to improve efficiency and quality with the global supply chain.

The strengthened DLE alternative would provide for improved oversight of the logistics supply chain and enable the planning and assessment needed to support the Enhanced Planning Process. This alternative would not address all logistics areas. The Services, Joint Staff, Transportation Command, and Defense Agencies would continue to control most of the resources and line of authority. This alternative would further retain the current, decentralized infrastructure that supports the logistics operations (depots, repair facilities, and organic manufacturing).

ALTERNATIVE 2: CENTRALIZED LOGISTICS/JOINT COMMAND

This alternative would further centralize logistics planning and management by establishing a single Logistics Global Supply Chain Organization (Joint Command/Agency) with oversight and decision authority for all defense materiel, maintenance, movement, and transportation. The organization would control the funding for Service and joint materiel. Consolidation of the organic repair capabilities would greatly improve their operations and efficiencies. This alternative also would do the following:

- ◆ Consolidate all funding for joint and single Service materiel and logistics support by creating an appropriation authority; execution authority would

be performed by newly established entities previously part of Services and Defense Agencies

- ◆ Provide total asset visibility and accessibility for all DoD materiel
- ◆ Create Department-wide policies and procedures for common logistics practices and procedures, including financial investments
- ◆ Incorporate all duties and responsibilities of the proposed DLE.

This alternative would enhance warfighter support and readiness by consolidating management of key Department logistics capabilities. The organization would be a critical part of the planning process for strategy, operations, and capabilities. The disadvantages of this alternative include (1) it restricts Service flexibility in the key Title 10 areas of equipping and sustaining and (2) it would require reallocating Component assets to create a large agency or command to manage logistics.

ALTERNATIVE 3: CORPORATE LOGISTICS

This alternative would adopt radical governance structures to meet Department logistics requirements by retaining core or critical operations and using non-DoD assets to meet remaining needs. Most logistics responsibilities would be removed from the Services and Defense Agencies and be placed in an entity (Command structure most likely) reporting to OSD. The alternative structure could include public-private partnerships, federal government corporations, and Employee-Owned Stock Ownership Program (ESOP) entities.

At an extreme, the retained functions could be limited to combat logistics or in-theater operational support. Overall, the intent would be to find the best means and provider through a comprehensive business case analysis that includes the flexibility and reliability needed to support the joint warfighter. Innovative contracts and incentives would be needed to fully implement this alternative.

This alternative would also do the following:

- ◆ Divide logistics services along functional lines (such as combat logistics and operational support) with selected items remaining in DoD. These operations would be run on a commercial basis with a term appointment (for example, 6 years).
- ◆ Develop and publish a Strategic Logistics Plan and coordinate execution with subordinate Command entities.
- ◆ Integrate best business practices into the logistics planning and execution processes, along with commercial-like entities to perform the mission.

Given the variety of options available, this alternative offers great flexibility and optimizes logistics investments for the Department. The disadvantages include the possibility of increased fragmentation of the integrated supply chain, major impact on DoD and Service organizations, and the need for Congressional consultation and approval for some of the changes.

Infrastructure

As with the other enterprise functions, the responsibilities, information, funding, and overall control of infrastructure is dispersed among multiple Components, with little or no strategic capability planning. Infrastructure planning is focused on the maintenance and support of existing facilities, with little emphasis on consolidation and divestiture. Recent direction suggests a greater emphasis on joint-use facilities, but implementation of this concept in DoD-wide capabilities planning has been minimal.

The proposed infrastructure alternatives are designed to provide organizational changes that would increase the participation of infrastructure owners/managers in the Department's capabilities analysis, decision, and integration processes. The goal is to develop DoD-wide infrastructure plans that are integrated to meet joint needs, are efficiently organized to reduce cost, and directly support current and future operation and capability plans.

ALTERNATIVE 1: JOINT FACILITIES DIRECTORATE

The moderate alternative to the Department's infrastructure organization entails the establishment of a Joint Facilities Directorate (JFD). The JFD would be organized by modifying the current OSD staff to better participate in the Department's capabilities analysis and integration processes. Portions of the OSD staff would be realigned to support the JFD, which would reside in OUSD(AT&L). The JFD would become the focal point within the Department for infrastructure issues to meet joint capabilities and serve as the lead for infrastructure related issues within the Enhanced Planning Process. It would head a Joint Facilities Board (JFB), which would lead the effort to define needs across the Department and coordinate execution activities. Special emphasis would be placed on facilities that most directly support the joint warfighter, such as depots, training ranges, and certain bases. However, Components would still maintain execution authority for assigned infrastructure.

Additional features of this alternative are as follows:

- ◆ The JFD would develop and publish a Strategic Infrastructure Plan (building on the work in the Defense Facilities Strategic Plan) that
 - contains a comprehensive view of Department assets and how they support joint needs,

-
- is consistent with the SPG, and
 - integrates best business practices into the planning and execution processes.
 - ◆ The JFD would develop and publish appropriate directives to manage joint infrastructure requirements.
 - ◆ The process would link to other enterprise functions (such as logistics) for planning.

The major advantage to this alternative is that it could reduce costs through better utilization of resources such as eliminating excess capacity and maximizing joint use of facilities. In addition, it would provide a centralized integrated planning structure for all Department infrastructure requirements. A disadvantage to this alternative is the requirement to realign current organizations to meet staffing requirements.

ALTERNATIVE 2A: ASD, INSTALLATIONS AND ENVIRONMENT—JOINT

The Study Team identified two aggressive infrastructure alternatives. Both alternatives would create an Assistant Secretary of Defense (ASD), Installations and Environment, within OUSD(AT&L), but with different responsibilities.

In this first aggressive infrastructure alternative, the ASD would resource and direct selected joint infrastructure functions across the Department. The ASD staff would have facilities planning and oversight functions for the Department and resourcing and directive responsibilities for those facilities and activities that most directly support the joint warfighter. To facilitate these actions, the ASD would maintain and direct a percentage of the overall DoD infrastructure budget to support joint needs, with financial reporting to track execution and performance. Execution authority would remain with the designated or appropriate Service or Agency. The ASD would provide directed guidance on joint infrastructure needs and delegate guidance to Services and Agencies on the management of assigned infrastructure.

The ASD would develop and publish a biennial Strategic Infrastructure Plan (building on the work currently done in the Defense Facilities Strategic Plan), that

- ◆ links to logistics requirements,
- ◆ provides a comprehensive view of departmental assets and how they support joint needs,
- ◆ is consistent with the SPG, and
- ◆ integrates best business practices into the planning process.

Having an ASD that directly supports the capabilities-based focus of the Department's joint infrastructure needs is a significant advantage of this alternative. As with the moderate alternative, the Department would reduce its costs. This alternative would provide centralized resourcing, direction, and integrated planning for all joint infrastructure requirements. A disadvantage is that this alternative would require realignment of existing OSD organizations and could generate legislative issues.

ALTERNATIVE 2B: ASD, INSTALLATIONS AND ENVIRONMENT—DoD-WIDE

In this second aggressive infrastructure alternative, the ASD, Installations and Environment, would resource and direct DoD-wide infrastructure functions across the Department, while execution authority would remain with the designated or appropriate Service or Agency. The ASD would have facilities planning and oversight functions for the Department and resourcing and directive responsibilities for all DoD infrastructure. The ASD would also provide directed guidance on specific infrastructure needs and delegate the remainder to Services and other Agencies for management of assigned properties. To facilitate these actions, the ASD would maintain and direct the overall DoD infrastructure budget, with financial reporting to track execution and performance. As with the previous alternative, the ASD would develop and publish a biennial Strategic Infrastructure Plan.

The primary advantage of this alternative is that it would provide a centralized, single manager who directly supports the capabilities-based focus of the Department's total infrastructure needs. Costs would be reduced through better utilization of resources, focused on eliminating excesses and maximizing joint assets. This alternative would require realignment of existing OSD organizations and significant changes in DoD policy. In addition, significant legislative issues would arise with the redirection of infrastructure resources away from the Services and Agencies to the ASD.

ALTERNATIVE 3: DoD CORPORATE INFRASTRUCTURE

The radical alternative would merge all DoD infrastructure under an OSD-led entity. Ownership would be removed from the Services and other Agencies and be placed under the responsibility of this OSD entity. The infrastructure services would be divided along functional lines (such as housing, hospitals, airfields, and ports), regional lines (west, east), or a combination of functional and regional lines. The OSD entity would oversee alternative governance structures for the various infrastructure services as appropriate. Those structures could include performance-based organizations, cooperative partnerships, federal government corporations, GOCO entities, and public-private partnerships or ventures. Under this alternative, OSD would develop and publish a Strategic Infrastructure Plan.

The advantages to this alternative are that decisions would be insulated from Service or Agency agendas, the return on the facilities investment would be maximized, and the alternative governance structures would provide increased flexibility in personnel and acquisition matters. However, the profit motive of cer-

tain governance structures could conflict with DoD's needs. In addition, this alternative would require new organizational structures, and the potential exists for fragmented support from using a multitude of service providers. More importantly, some of the required changes would require Congressional approval.

Workforce Planning

As with the other functional elements of the enterprise domain, workforce development is often reactive to decisions concerning joint capabilities, rather than being fully considered when those decisions are made. To effectively support the new planning processes, human capital needs must be addressed systematically and proactively. Two major changes are required to achieve that goal: workforce and training requirements must be fully incorporated into the analyses of alternatives for all capabilities, and the pool of experts available to perform those analyses must be greatly expanded.

The current organizational structure is adequate to support the Enhanced Planning Process. However, the scope and depth of workforce analyses must vary to support the broader Department- and corporate-level alternatives for the planning process (see Appendix M).

In all alternatives, workforce requirements (e.g., number of people, skills, and training) would be systematically included in the analyses of all options to fill capabilities gaps or to reduce overlaps. Projections of future requirements of civilian and contractor personnel would augment current Service planning, which focuses almost exclusively on military manpower. OSD (Personnel and Readiness) would consolidate Service and Agency projections for military personnel, civilian employees, and contractors, to produce a Department-wide picture of future needs. All human resources planning would take into account active and reserve roles in future operations. Steps would be taken to better link single-Service training events to joint warfighting needs, as established by the Joint Staff and Joint Forces Command.

Chapter 4

Implementation

WHY CHANGE

The United States cannot definitively predict who its next adversary will be or where the next conflict will occur; nevertheless, its military forces must be able to successfully meet the uncertainties of this new era. The Department of Defense may have produced the best armed forces in the world, but its processes do not optimize the investment in joint capabilities to meet current and future security challenges. The time is ripe to improve DoD's processes for determining needs, creating solutions, making decisions, and providing capabilities to support the joint warfighters. A capabilities-based approach to making those improvements would mitigate much of the uncertainty by emphasizing the nation's ability to shape the battlefield, regardless of whom we fight or where we fight.

The Joint Defense Capabilities Study Team examined past and current studies and developed recommendations for streamlined processes and for alternative organizations to better integrate defense capabilities in support of joint objectives. If implemented, these recommendations would dramatically change the way the Department does business because they focus on delivering capabilities to meet a wide range of security challenges rather than defeating a specific adversary. The next step is to bring about the necessary changes in the Department by implementing the recommendations, an important and challenging task that is critical to successfully meeting the security demands of the future.

LEADING CHANGE

John P. Kotter, professor of leadership at Harvard Business School, has written extensively about change. In his book, *Leading Change*, he writes that although the need for change is widely recognized and acknowledged, creating that change and, more important, making the change "stick" are extremely difficult. Kotter details eight common errors in organizational change efforts:

1. Allowing too much complacency
2. Failing to create a sufficiently powerful guiding coalition
3. Underestimating the power of vision
4. Under-communicating the vision
5. Permitting obstacles to block the vision

-
6. Failing to create short-term wins
 7. Declaring victory too soon
 8. Neglecting to anchor changes firmly in the corporate culture.

For most organizations, the biggest challenge is leading change. Only leadership can blast through the many sources of bureaucratic inertia; motivate the actions needed to alter behavior in any significant way; and get change to stick by anchoring it in the very culture of the organization.

But leadership cannot be confined to one larger-than-life individual who charms thousands into being obedient followers. Large organizations like DoD are far too complex to be transformed solely by the strength of a single personality. The leadership effort includes many senior leaders from across the Department—Principal Staff Assistants, CJCS, Combatant Commanders, Service Secretaries, and Joint Chiefs—who must push the new agenda within their sphere of activity. These leaders and their staffs are the stakeholders in the new joint capabilities-based process and must take ownership of it to ensure its successful adoption.

The recommendations and actions found in this report will demand a dedicated effort to ensure successful implementation. Given the broad nature of the processes and the extent of the changes being recommended, a strong commitment to implementation is critical for success. Without leadership's strong commitment to implementation, not only will results be suboptimized, but the current, ineffective processes will continue to our detriment.

CREATING AN IMPLEMENTATION TEAM

Critical to any successful change initiative is the change management or implementation team that works with the leadership to keep change efforts on track. The head of this team should have direct access to the leadership of the Department, especially the Secretary and Deputy Secretary of Defense. The head of the team and supporting staff will need to establish a Department-wide governance process to drive the change effort. This process should clearly spell out what needs to be done, who needs to do it, and when it needs to be completed. Regular progress reviews should be given to the Department leadership.

Equally important is the need to communicate the need for change, the goal of the change effort, and the organization's progress toward meeting that goal. Both internal and external communication strategies need to be created, and the implementation team, working closely with Public Affairs, should spearhead these efforts. These communication strategies should educate, train, and enable the stakeholders to fully embrace the new capabilities-based approach. For general awareness and widespread access, a website dedicated to the new process should be created. More traditional methods such as pamphlets, press releases, and speeches also should be pursued. The audiences for these communication efforts

should include DoD’s workforce, the “school houses,” industry and trade associations, and the Congress.

Not all of the proposed changes involve processes; some changes to the organizational structure will be needed as well. With the initiation of a joint capabilities-based process, the planning process will require a fundamental realignment. Organizational changes involving the planning process could range from changes within existing organizations to the creation of totally new organizations.

Regardless of the nature of the change, the results should be captured in the formal documentation of the Department. Directives, instructions, manuals, and other documents will need to be altered to reflect the process and organizational changes. These documents should be reviewed and updated, and the new documents widely distributed. These actions are critical particularly as the responsibility for change transfers over time from the implementation leader—who sets the process and organizational changes in place, guides the transition process, maintains the focus and key principles, and establishes a Department-wide governance process—to the stakeholders themselves.

Through his experience in observing change efforts in many organizations, John Kotter has developed an eight-stage model for implementing change. Each stage is associated with one of the eight fundamental errors (listed above) that undermine transformation efforts:

- ◆ Establish a sense of urgency
- ◆ Create the guiding coalition
- ◆ Develop a vision and strategy
- ◆ Communicate the change vision
- ◆ Empower a broad base of people to take action
- ◆ Generate short-term wins
- ◆ Consolidate gains and producing even more change
- ◆ Institutionalize new approaches in the culture—in other words, to ground the changes in the corporate culture and make them stick.

This eight-stage model could provide the foundation for the Department’s transition to joint capabilities-based planning and ground the changes in the corporate culture and make them stick. In seeking those objectives, the Study Team further recommends that DoD make a concerted effort to follow this eight-stage model and to “hand off” as much responsibility as possible from the implementation

leader to the process owners within the next year. The handoff (depicted in Figure 4-1) includes the following key activities:

- ◆ Change agents develop around new processes and organizations
- ◆ Leaders inherit institutional knowledge and principles
- ◆ Responsibility for oversight of remaining change is transferred to new process owners and organizations
- ◆ SECDEF manages through the governance process.

Figure 4-1. Successful Change Effort with Handoff

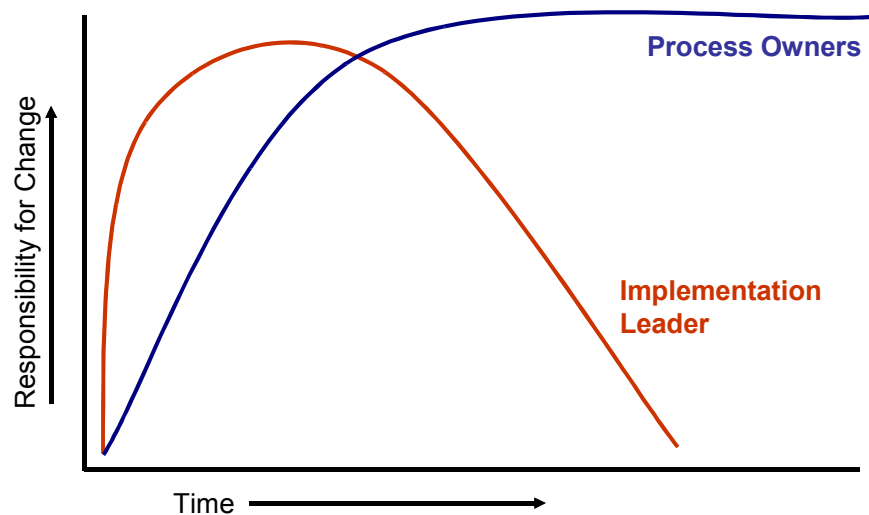

SUMMARY

The success of moving to a joint capabilities-based process depends on leadership support and involvement, and on a strong implementation team. Together they need to communicate Department goals, map out what it takes to achieve the goals, and hold people accountable for meeting them. These are the essential ingredients to implementing change.

If DoD works through these steps, it will be successful. The recommendations for change found in this report are only one part of the change process. The follow-through that takes place in the implementation phase is crucial to getting to the finish line and making the changes stick. This effort is too important to the Department of Defense not to see it through to a successful conclusion.

Appendix A

Implementation Memoranda

Initiation of a Joint Capabilities Development Process Memorandum	A-2
Integrated Priority Lists Memorandum.....	A-4



THE SECRETARY OF DEFENSE
1000 DEFENSE PENTAGON
WASHINGTON, DC 20301-1000

OCT 31 2003

MEMORANDUM FOR SECRETARIES OF THE MILITARY DEPARTMENTS
CHAIRMAN OF THE JOINT CHIEFS OF STAFF
UNDER SECRETARIES OF DEFENSE
DIRECTOR, DEFENSE RESEARCH AND ENGINEERING
ASSISTANT SECRETARIES OF DEFENSE
COMMANDERS OF THE COMBATANT COMMANDS
DIRECTOR, PROGRAM ANALYSIS AND EVALUATION
DIRECTOR, ADMINISTRATION AND MANAGEMENT
DIRECTORS OF DEFENSE AGENCIES

SUBJECT: Initiation of a Joint Capabilities Development Process

In view of the challenges we face now and in the future, I have decided to change how we develop and execute programs to ensure that our programs serve joint needs and effectively balance current and future risks. This memorandum provides initial guidance for the transition to the new process.

The way forward was discussed by the Senior Leadership Review Group (SLRG) on September 12. The goal is a streamlined and collaborative, yet competitive, process that produces fully integrated joint warfighting capabilities. While some organizational changes may ultimately be needed to optimize the new process, its initial implementation will be carried forward by existing organizations. Changes will begin this fall with the introduction of several new features:

- In December, I will issue the Strategic Planning Guidance (SPG), a single, fiscally-informed document that will replace the policy/strategy sections of the Defense Planning Guidance (DPG). The SPG may include programmatic guidance on a few issues of paramount importance. (Lead: Mr. Henry).
- Between now and next spring, an enhanced, collaborative joint planning process will formulate and assess major issues and present them for my decision (Co-Leads: Mr. Krieg; LtGen Cartwright; Mr. Henry). This process will result in decisions on major issues and metrics and measures of sufficiency for other elements of the Defense program. To initiate this process, Mr. Henry, in conjunction with Mr. Krieg and LtGen Cartwright, and in consultation with the membership of the SLRG, should provide me a list of candidate major issues by November 14th.



U18136 /03

- In the spring, I will issue fiscally constrained Joint Programming Guidance (JPG) that will record the decisions reached in the enhanced planning process. The JPG will replace the programmatic elements of the DPG and will include a demonstration that the totality of the programmatic guidance provided in the SPG and JPG is fiscally executable. (Co-Leads: Mr. Krieg; Dr. Zakheim).
- In the fall, the defense resourcing process will conclude with an integrated program/budget build and a review to ensure that the program and budget are fully responsive to the SPG and JPG (Co-Leads: Mr. Krieg; Dr. Zakheim). This process will include negotiation of DoD top-line budget authority with the Office of Management and Budget (Lead: Dr. Zakheim).

These changes will support a simplified resourcing process, in which programs and budgets are developed in response to the JPG and are reviewed for compliance with it.

In practice, success will depend on feedback from an annual review of how well program implementation and budget execution are meeting identified joint warfighting needs. (Leads: Mr. Krieg; Dr. Zakheim; LtGen Cartwright; Mr. Henry). The organization of the review and the communication of its results will be greatly improved by development of a common structure for articulating joint capabilities. While this year's transitional process will begin with the capability categories recently developed by the Joint Staff, those categories will require further refinement to support the end state as the joint operating concepts evolve. Further development of refined categories should begin immediately (Co-Leads: Mr. Henry; Mr. Krieg; LtGen Cartwright).

In all of these activities, the designated leads should consult the standing three-star group that supports guidance development and the program and budget reviews. I expect all stakeholders in the Department to participate in these efforts to address joint operational needs effectively and to improve the management of Defense resources. Further detail and additional guidance will be provided in separate memoranda. My point of contact for this matter is Mr. Ken Krieg.





THE SECRETARY OF DEFENSE
1000 DEFENSE PENTAGON
WASHINGTON, DC 20301-1000



OCT 27 2003

MEMORANDUM FOR THE COMBATANT COMMANDERS

SUBJECT: Integrated Priority Lists

With the FY 2006-2011 program development cycle, we will introduce a streamlined and refocused Integrated Priority List process that reflects the Department's emphasis on capabilities-based planning.

The goal of the revamped Integrated Priority List is to produce a succinct statement of key capability "gaps" that could hinder the performance of assigned missions. The Integrated Priority Lists should thus be limited to those critical issues that you believe need the personal attention of the senior department leadership, including the Chairman and me. The revised process will include several new features:

- In lieu of defining programs or assets, the Integrated Priority Lists will identify potential capability shortfalls that could limit the ability of your commands to carry out responsibilities identified in the Contingency Planning Guidance, Security Cooperation Guidance, or Defense Planning Guidance. Each capability gap must be linked to specific guidance.
- In addition to your written Integrated Priority List submissions, you will have the opportunity to brief me and the Chairman.
- Any deficiencies identified in the Integrated Priority Lists will inform the Strategic Planning Guidance for FY 2006-2011.

Please submit your Integrated Priority Lists by November 17. In developing the Integrated Priority Lists and the briefing for the Chairman and me, you should focus on the capability categories recently identified by the Joint Staff. Within that general framework, you may modify the categories as necessary to address your specific concerns.

Additional guidance will be provided separately by the Director for Program Analysis and Evaluation.



U17242 /03

Appendix B

Products for Secretary of Defense and Senior Leadership Review Group

Study Team Briefing to the SecDef (19 Jun 03).....	B-2
Senior Leadership Review Group Brief (12 Sep 03).....	B-7
Senior Leadership Review Group Brief (31 Oct 03).....	B-14



***A DoD “Process” Study for
Enabling Joint Force Capabilities***

***Briefing to the Secretary of Defense
June 19, 2003***

Agenda

- **Assumptions**
- **“As Is” – what problems are we trying to solve?**
- **Desired “End State” attributes**
- **Process definition – what would be different?**
- **Next Steps – options to get to “End State”**

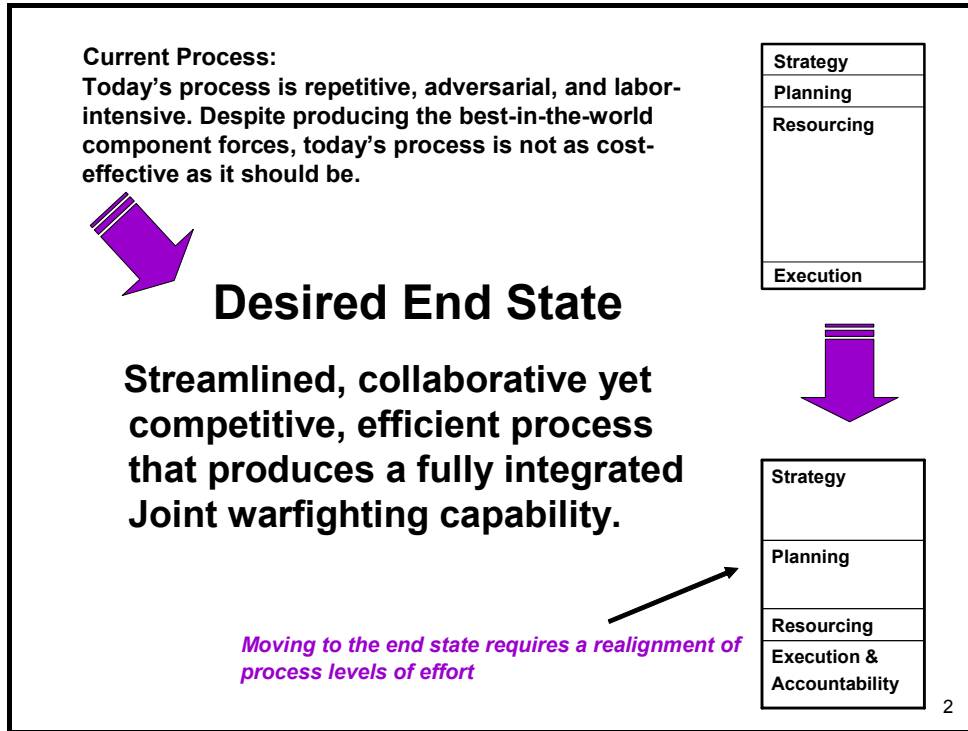

- ## Assumptions
- Implement for FY06 FYDP; 80% solution is acceptable
 - Study will assess processes first, then consider implications for organization, etc.
 - Services and Combatant Commanders will remain intact
 - Capabilities must be optimized across the Department, not within Components, to support near and far term joint warfighting needs
 - Decisions must be based on open and explicit analysis
 - Response times for innovation, decision making, and implementation must be shortened
 - The choice of acceptable level of risk needs to be made by senior decision makers through a collaborative process, not through a consensus-driven process at lower levels
 - New processes must remain viable with level or reduced resources
- 3

The "As-Is" Baseline

Process

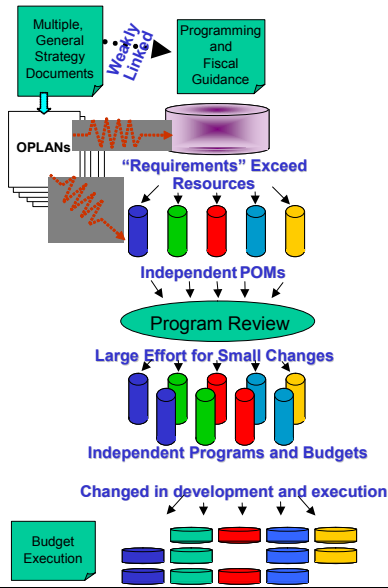

Problems

- No single statement of what needs to be done and how the Department should do it.
- Joint needs and guidance are not integrated, prioritized, or fiscally informed.
- Components build programs before guidance is received
- Components cannot fund all elements of the guidance.
- Programs optimized to meet Service / Agency requirements and varying interpretations of the guidance.
- Combatant Commander input to "Requirements" is uneven, near-term focused, and overshadowed by Service influence.
- Skill vs. need planning mismatch in the workforce.
- No provisions to allow tradeoffs between Components.
- Leadership engages too late to effect large changes.
- Gaps and overlaps in Joint capabilities.
- Service capabilities "forced" Joint, not "born Joint."
- Tradeoff of capability within, not across Services.
- Total program does not maximize cost-effectiveness.
- Measures dollar input vice capability outcomes.
- Schedule slips, cancellations, reductions in quantity.
- Cumbersome processes discourage non-traditional suppliers.
- Overall program is not as cost effective as it should be.

4

"As-Is" Versus End State

Major Process	"As-Is" Problems	End State Attributes
Strategy	<ul style="list-style-type: none"> ▪ Multiple documents ▪ Joint needs and guidance not integrated, prioritized, or fiscally informed 	<ul style="list-style-type: none"> ▪ Single translation of NSS into Department objectives, priorities and risk tolerance ▪ Conceptual framework and focus for planning and capability development ▪ Resource informed Strategic Planning Guidance
Planning	<ul style="list-style-type: none"> ▪ Defense Planning Guidance (DPG) is provided late and is not fiscally constrained ▪ DPG is developed by OSD ▪ The DPG makes little, if any, provision for tradeoffs among Components 	<ul style="list-style-type: none"> ▪ "Jointness" is born at the beginning of the process. ▪ Joint Programming Guidance is provided early and is fiscally constrained ▪ Developed collaboratively, with extensive involvement by Combatant Commanders and Components ▪ Articulates a single statement of <u>joint needs</u> that reflects decisions on tradeoffs among Components
Resourcing	<ul style="list-style-type: none"> ▪ Components' programs cannot comply with all of the requirements of the DPG ▪ Adversarial, labor-intensive process ▪ Senior leadership forces "Jointness" into the process at the end, with great effort. ▪ Gaps and redundancies in Joint capabilities render the Defense program cost-ineffective 	<ul style="list-style-type: none"> ▪ Collaborative, efficient process produces early decisions ▪ Senior leadership attends to issues of compliance and executability
Execution and Accountability	<ul style="list-style-type: none"> ▪ Focus on expenditure / adherence to regulations ▪ Prolonged and complicated process to produce new capabilities ▪ Human capital planning and costs are not addressed ▪ Logistics & acquisition cycle time and support are not timely or cost-effective ▪ Execution data not useful for decision making 	<ul style="list-style-type: none"> ▪ Focus on performance / results ▪ Reduced cycle-time so that capabilities are developed to meet emerging needs ▪ Human capital managed strategically ▪ Full costs (acquisition and logistics sustainment) considered and continually refreshed ▪ Execution performance serves as a starting point for next planning cycle

5

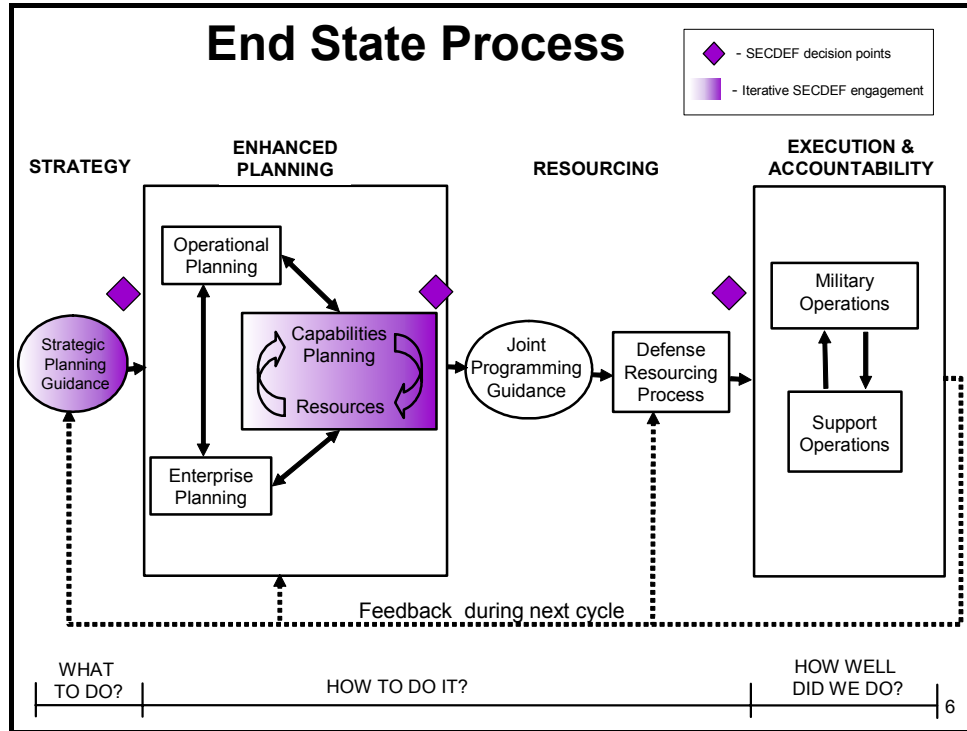

- ### What's Different?
- **New Strategic Planning Guidance (SPG) and Joint Programming Guidance (JPG)**
 - **SPG and JPG are fiscally achievable**
 - **OSD, JCS, Services, and CoComs have shared values and objectives**
 - **New collaborative process to achieve Joint capabilities**
 - **New process measures output rather than input**
 - **New process allows Services to compete to provide capabilities; and the Secretary of Defense to make early trade-offs among Components**
- 7

Next Steps

- **Phase 1 Determine Study Azimuth: (May – June)**
 - Review ongoing change efforts
 - Develop a desired end state for the proposed changes
- **Phase 2 Build Alternatives : (July – August)**
 - Develop alternatives to meet the desired end state
 - Determine the resource, organizational, process, and other implications of each alternative

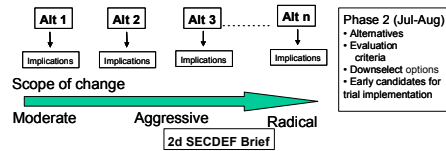

- **Phase 3 Evaluate Alternatives: (September – October)**
 - Assess suitability, feasibility, and acceptability of alternatives to achieve end state
 - Conduct “Business Game” of selected alternatives
 - Provide recommended option(s)
- **Phase 4 Implement Decision: (November – December)**
 - Execute decision guidance to produce chosen alternative
 - Provide a transition / implementation plan

Senior Leadership Review Group Brief (12 Sep 03)



Joint Defense Capabilities Study

briefing to the

Senior Leadership Review Group

September 12, 2003



Study Charter and Membership

***Commissioned by Secretary Rumsfeld in
March 2003 to:***

**Provide streamlined processes, alternative
functions, and organizations to better
integrate Defense capabilities in support of
joint warfighting objectives**

Study Team Membership

Study Lead- Pete Aldridge
Study Director- Mary Margaret Evans
Study Team- Representatives from:
Joint Staff, USJFCOM, Services,
USD(C), USD(P&R), ODPAE, ODA&M



Assumptions and Guidance

- Implement for FY06 FYDP; 80% solution is acceptable
- Capability-based processes identify joint needs up front; Services supply these needs
- Capabilities must be optimized across the Department, not within Components, to support near- and far-term joint warfighting needs
- Acceptable risk levels should be identified up front by senior decision makers in a collaborative, vice consensus-driven, process
- Combatant Commanders' input is critical

*Focus on processes first,
then consider organizational implications*

2



Study Phases

- Phase 1- Develop "as-is" baseline and desired end state
- Phase 2- Build draft process alternatives and their attributes to meet the desired end state
 - Identify critical actions for POM 06
 - Engage Combatant Commanders in process
 - Identify alternatives
 - Determine evaluation criteria
- Phase 3- Refine and develop organizational alternatives, based on SECDEF direction
- Phase 4 Implement Decision (November – December)
 - Study Leader recommendation to SECDEF
 - Provide a transition / implementation plan

Brief Today

3



**JOINT DEFENSE
CAPABILITIES STUDY**

**Elements of the Joint Defense
Capabilities Process**

- **Strategy** - What we want the DoD to accomplish - an integrated, resource-informed statement of the SECDEF's major Joint strategic objectives

- **Enhanced Planning** - How we want to accomplish the objectives of the strategy - A collaborative, competitive analytical process, leading to specific program goals

- **Resourcing** - Provides a fiscally executable program and budget that responds to prioritized Defense needs identified through the planning processes.

- **Execution & Accountability** - Reports from Military Departments and Agencies on how well the Department goals were met, in output terms

4



**JOINT DEFENSE
CAPABILITIES STUDY**

The Desired End State

Current Process:

Repetitive, adversarial, and labor intensive.
Produces best-in-the-world component forces,
but is not as cost-effective as it should be.

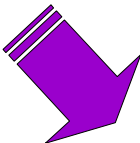

Desired End State

Streamlined, collaborative yet competitive,
efficient process that produces a fully
integrated joint warfighting capability.

Strategy
Planning
Resourcing
Execution

↓

Moving to the end state requires a realignment of effort

Strategy
Planning
Resourcing
Execution & Accountability

5

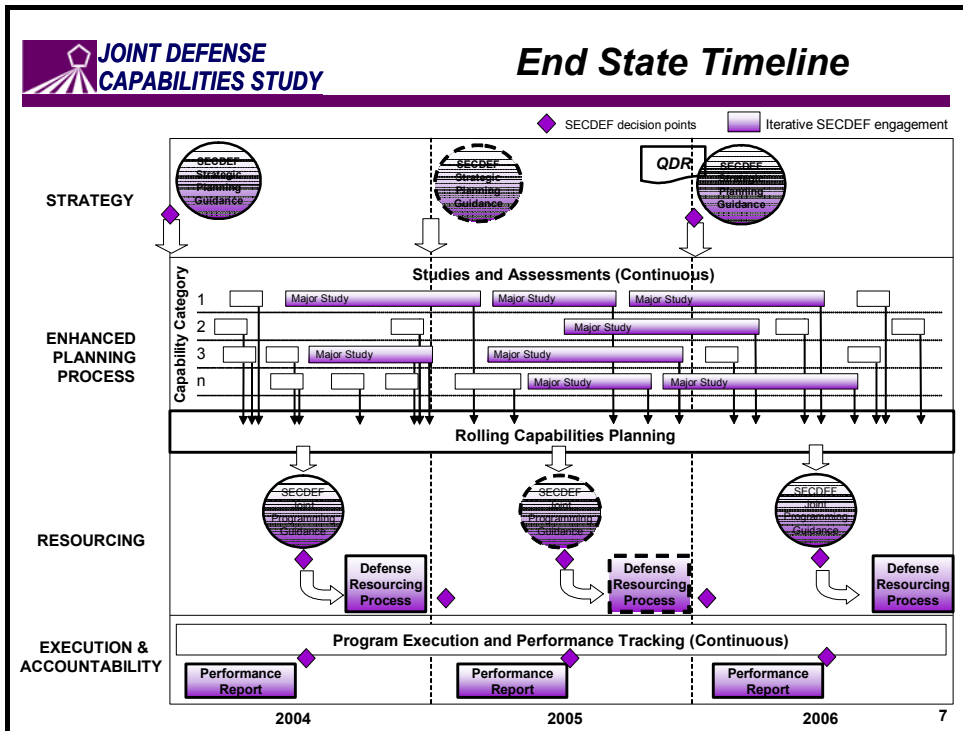
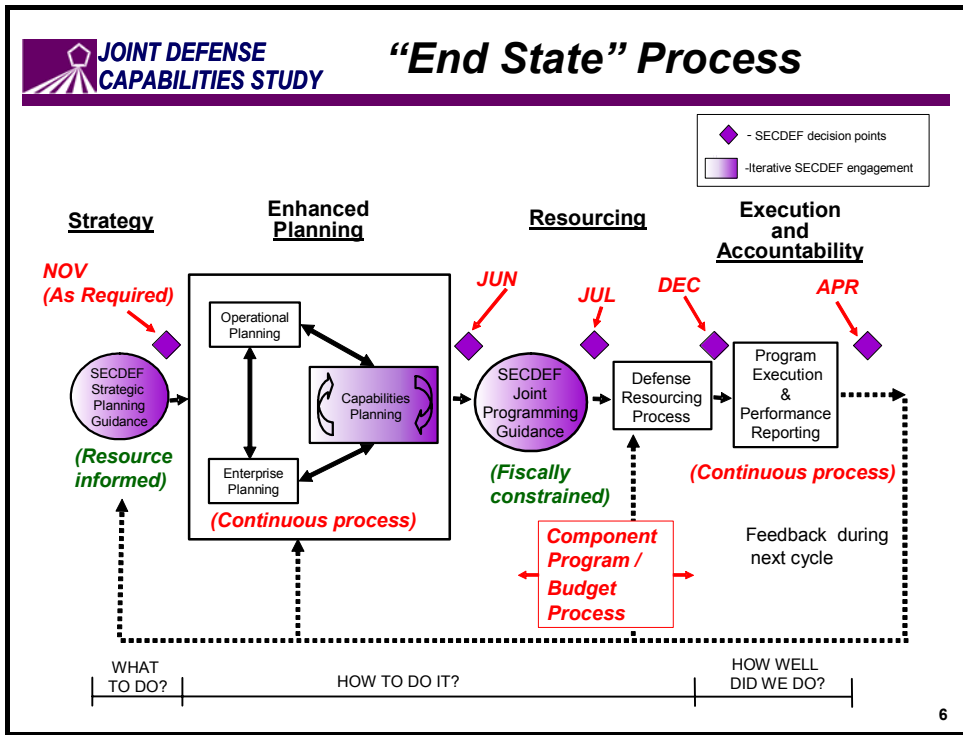

 **JOINT DEFENSE
CAPABILITIES STUDY**

What's Different?

- **SECDEF Strategic Planning Guidance – *What to do?***
 - Single, unified, resource-informed strategic guidance *that begins the planning cycle, not ends it*
 - Separate from programming guidance
- **Enhanced planning process where capabilities are “born joint” – *How to do it?***
 - Collaborative, but competitive, process involving all users and providers
 - Considers a wide range of alternatives and trade options
 - Capability categories express trades in meaningful terms across DoD
- **SECDEF Joint Programming Guidance – Fiscally constrained, directive guidance on key joint capabilities – *Do it!***
 - Remainder of program delegated to Services, with associated metrics
 - Up-front decision making prevents the Program/Budget Review “train wreck”
- **Annual performance review – *How well did we do?***
 - Focused on outcomes and meeting current and future joint warfighting needs

***Defense program driven by current and future joint needs
Combatant Commanders engaged throughout the process***

8

 **JOINT DEFENSE
CAPABILITIES STUDY**

Characteristics of the Organization to Support the End State

- A strong analytical planning and programming organization leads DoD capabilities-based planning and resourcing processes with a common framework, language, and toolset
- OSD and JS organized to support capabilities-based planning and resourcing processes, and trade-offs across functional and organizational lines
 - Both warfighting and infrastructure/support capabilities to be considered
- Need for independent program execution monitor

***Standard Joint Capability Categories should be used for
consistent organization and communication across the
Department***

9



Why Capability Categories?

- Provide a common framework to address Joint warfighting objectives
- Support the assessment of programs on the basis of their contribution to Joint capabilities, rather than their merits as an individual program
- Allow the identification of trade areas to support gap analyses and evaluation of program contributions to the capability
- Foster a “capabilities culture” that:
 - Simultaneously considers costs and needs
 - Provides a wide range of choices and competitive solutions to meet Joint warfighting needs
 - Timely consideration of risk by senior decision makers
 - Addresses both near and far term needs
 - Considers divestiture in tandem with initiatives

10



Moving in the Right Direction- Further Action is Needed

- MID 913 is a good start -
 - Two year budget cycle
 - Single Program/Budget database
 - Performance metrics
- Current DPG studies share characteristics of new process -
 - Increased Joint, CoCom, and Service collaboration
- Action required to -
 - Provide resource informed, prioritized, strategy guidance
 - Implement capabilities-based planning
 - Connect planning decisions to programmatic action

***Provide for iterative SECDEF decision making
throughout the process***

11

JOINT DEFENSE CAPABILITIES STUDY		Required Actions to Affect POM-06	
Action	Responsible Office(s)	Required By	
Joint Capability Categories – Develop standard joint capability definitions and a framework to express trades in meaningful terms across the Department.	JS, ODP&E, OUSD(P)	As soon as possible	
SECDEF Strategic Planning Guidance (SSPG) – Provide unified, resource-informed strategic objectives, key assumptions, priorities, fiscal projections, and acceptable risks. Identify selected Joint capability focus issues for analysis during FYDP 06. Focus on “what” needs to be done, not “how.”	OUSD(P), JS, ODP&E	Dec 03	
Capability Planning / SECDEF Joint Programming Guidance (SJPG) – Identify metric-based, outcome-focused capability needs on selected major joint issues. Assess competing options to meet the needs. Provide fiscally constrained programming guidance to implement SECDEF decisions.	ODPA&E, OUSD(C)	Apr 04	
Congressional Engagement – Begin discussions with key Congressional staffers regarding the presentation of budget information.	Study Team, OUSD(C), ODP&E, OASD(LA)	Fall 03	

All stakeholders (CoComs, Services, etc.) will participate at each stage

12

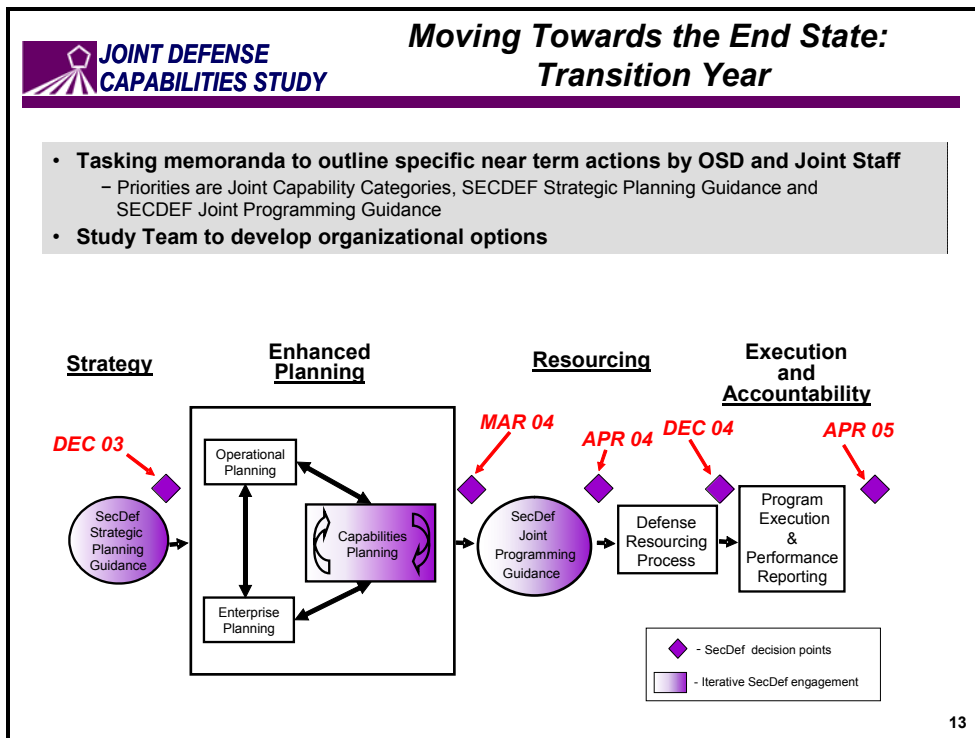

13



Joint Defense Capabilities Study

briefing to the

Senior Leadership Review Group

October 31, 2003



Agenda

- September 12th SLRG Recap
- Decision Process Details
- Implementation of the Process

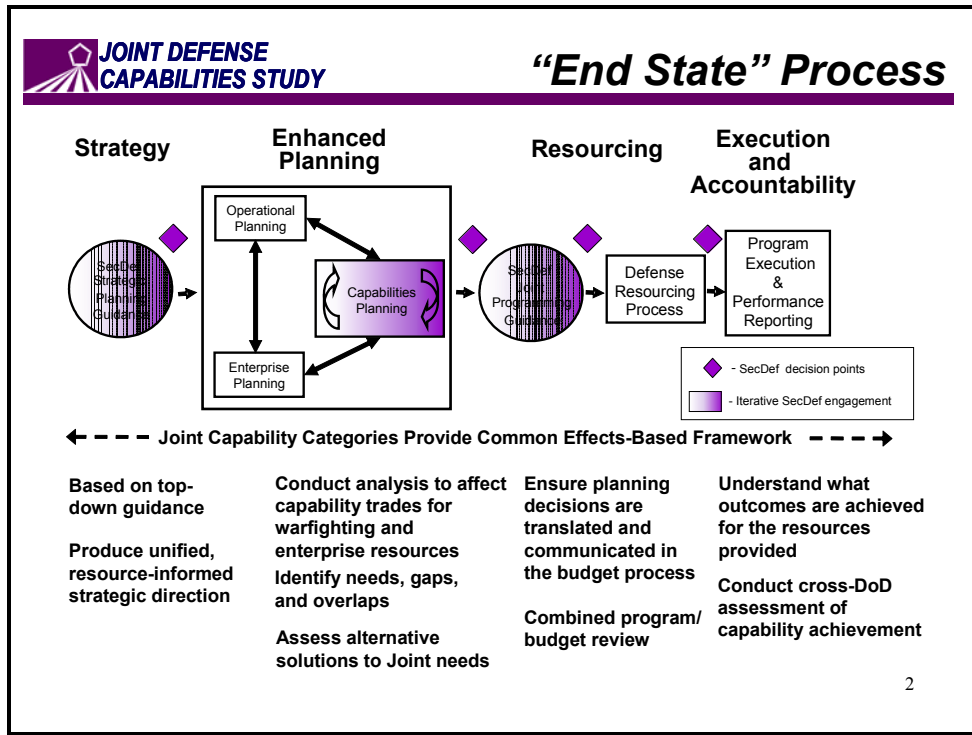

JOINT DEFENSE CAPABILITIES STUDY

Required Actions to Effect POM-06 (from 12 SEP)

Action	Lead Office(s)	Required By
Joint Capability Categories – Refine joint capability category definitions from those developed by the Joint Staff to best support the evolving Joint Operating Concepts and end state process.	ODPA&E OUSD(P) JS(DJ8)	Nov 03
SecDef Strategic Planning Guidance (SSPG) – Provide unified, resource-informed strategic objectives, key assumptions, priorities, fiscal projections, and acceptable risks. Programmatic guidance on issues of paramount importance only. Focus on "what" needs to be done, not "how."	OUSD(P)	Dec 03
Capability Planning – Identify metric-based, outcome-focused capability needs on selected major joint issues for FY06. Assess competing options to meet the needs and present for SecDef decisions.	ODPA&E OSD(P) JS(DJ8)	Identify issues: 14 Nov 03 Assess options: Apr 04
SecDef Joint Programming Guidance (SJPG) – Provide fiscally constrained programming guidance to implement SecDef decisions.	ODPA&E, OUSD(C)	Apr 04

All stakeholders (CoComs, Services, etc.) will participate at each stage

3

Strategic Planning Council

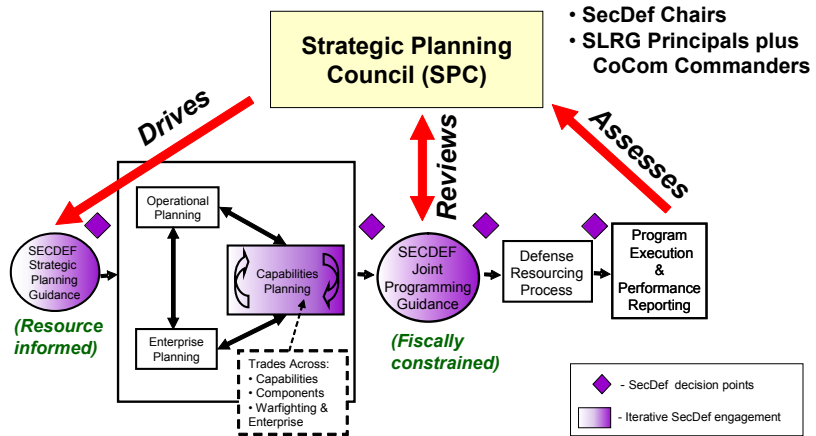

Corporate Board of Directors that:

- Drives strategy and frames major planning issues
- Reviews joint needs and solutions to ensure congruency with strategy
- Assesses feedback on execution performance

SPG Development Process

Organized by Capability Category

The SPG is produced as needed to communicate Defense strategy, top priorities, risk tolerance, and broad capability guidance. It is top-down and resource informed.

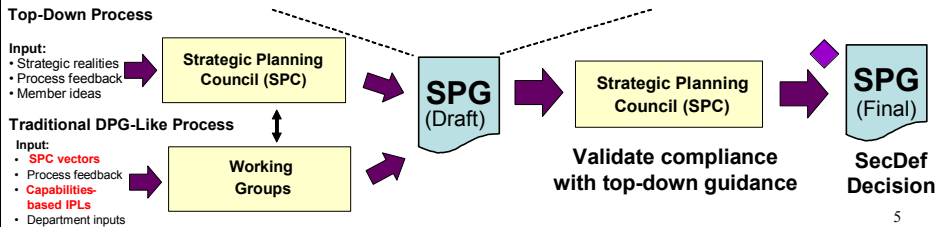
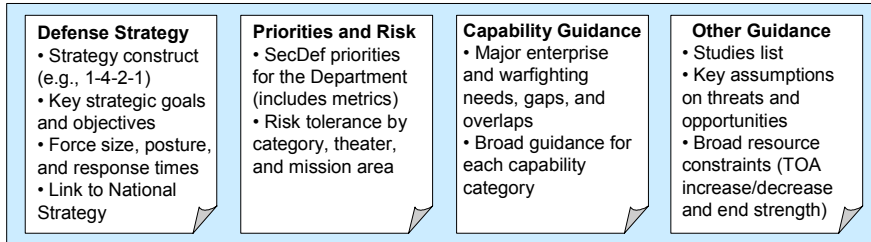

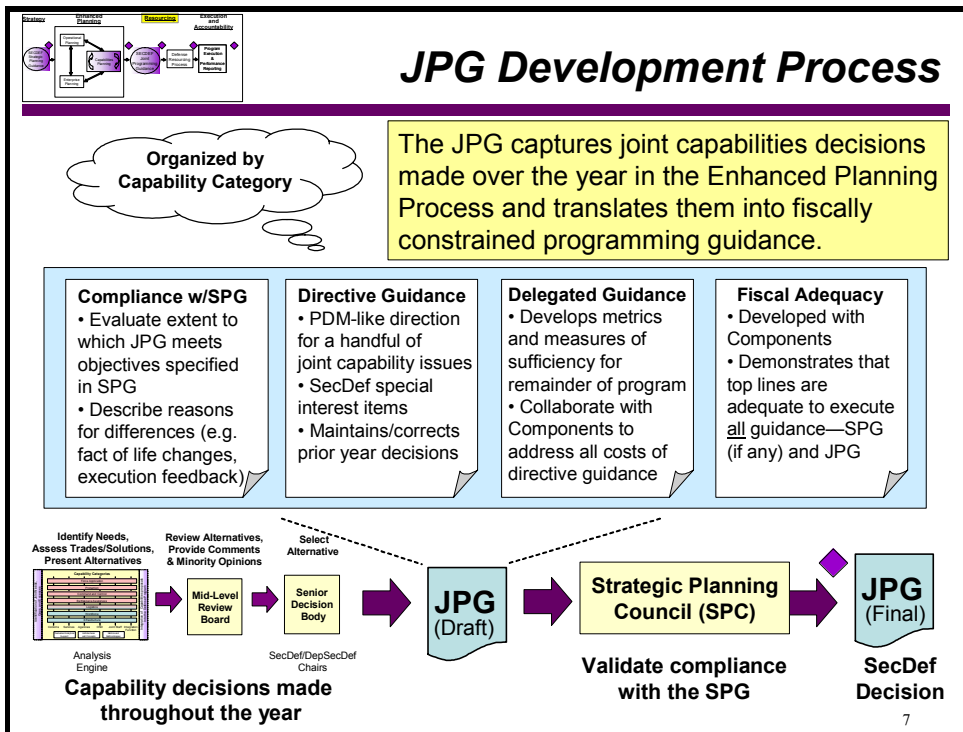
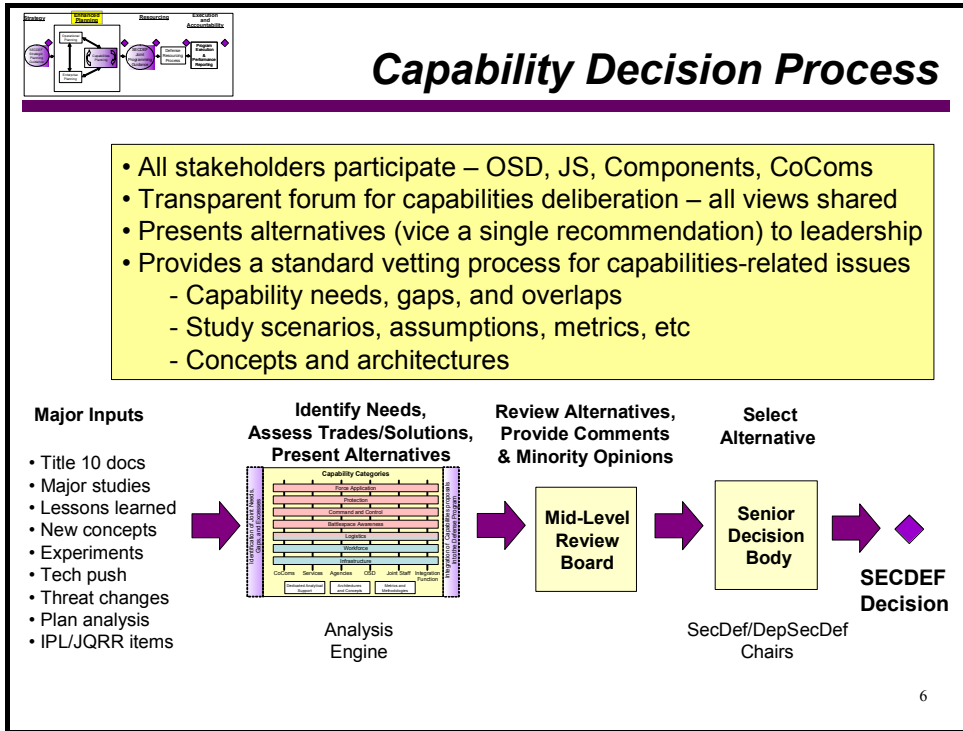

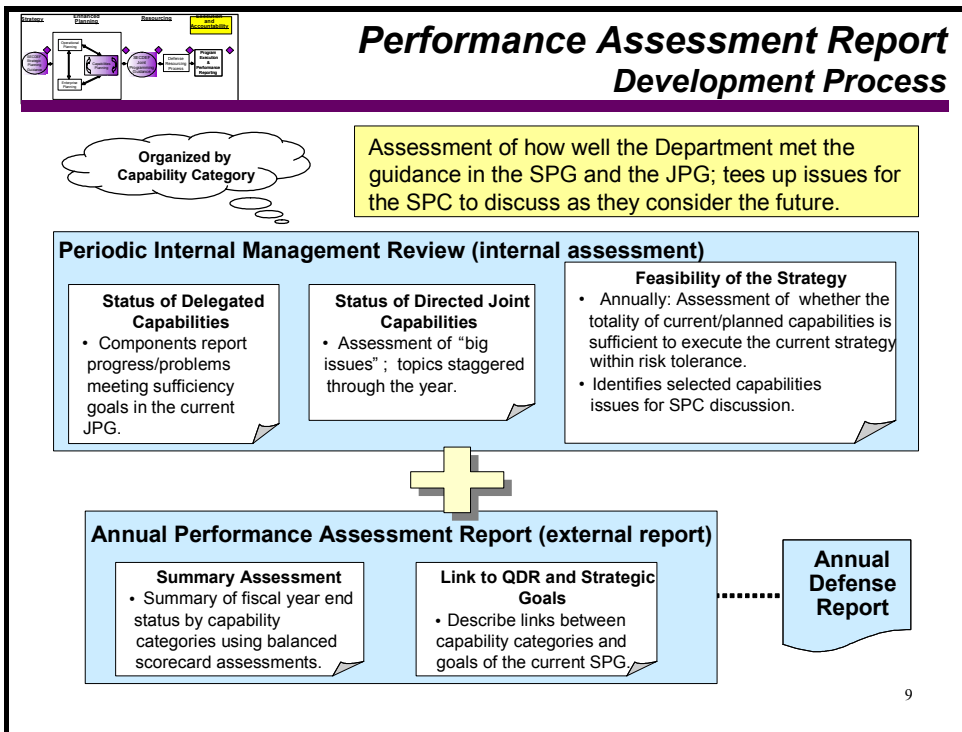
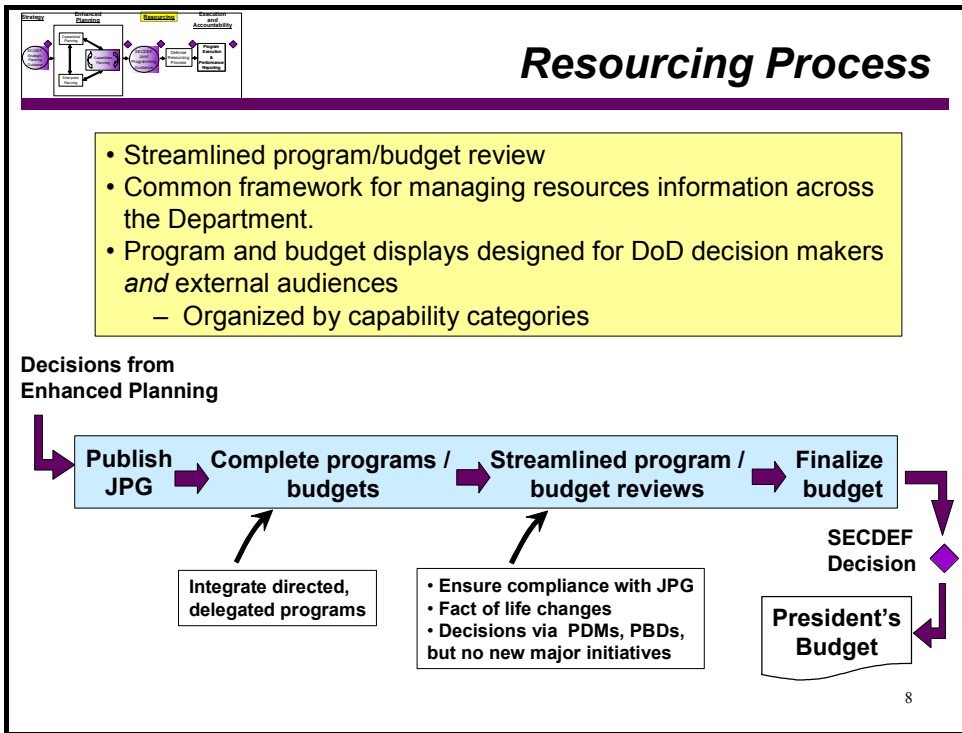



POM06 Approach

- FY06 SPG: strategic focus; programmatic guidance on issues of paramount importance
- Enhanced planning: conducted by issue teams and Functional Capability Boards (FCB)
- JPG: - directive guidance on major issues
 - delegated programming authority with metrics
 - proof of fiscal adequacy
- Execution/Performance
- Near term actions:
 - Sign Implementation Memo
 - Establish corporate decision making
 - Define interaction of issue teams and FCBs to address warfighting and enterprise issues/trades
 - Refine capability categories and their application
 - Define POM06 Strategic Issues

10

Appendix C

Key Assumptions and Guidance; Other Studies



**JOINT DEFENSE
CAPABILITIES STUDY** *Assumptions and Guidance*

- Implement for FY06 FYDP; 80% solution is acceptable
- Capability-based processes identify joint needs up front; Services supply these needs
- Capabilities must be optimized across the Department, not within Components, to support near- and far-term joint warfighting needs
- Acceptable risk levels should be identified up front by senior decision makers in a collaborative, vice consensus-driven, process
- Combatant Commanders' input is critical

*Focus on processes first,
then consider organizational implications*

- Joint Concept of Operations
 - **LtGen James Cartwright (J8), lead**
- DSB Task Force on Enabling Joint Force Capabilities
 - **Gen Larry Welch and Dr Bob Hermann, co-chairs**
- Streamlining Decision Processes (PPBS)
 - **Mr. Mike Dominguez (USAF), lead**
- Beyond Goldwater-Nichols
 - **Dr. John Hamre (CSIS), lead**
- Competency-based Management
 - **BrigGen Rich Hassan (USAF), lead**
- Core Competency Efforts by Services
 - **Mr. John MacDonald (USA)**
 - **Mr. Mike Dominguez (USAF)**
- OSD/JS Core Competencies & Collaboration
 - **Mr. Marty Hoffman, chair**
- Project Equinox (Organizational Approaches to OSD)
 - **Jeff McKittrick (SAIC), lead**
- Options for Improving Logistics
 - **Mr. Brad Berkson (AT&L), lead**
- MID 909 – Supply Chain Study
 - **Mr. Brad Berkson (AT&L), lead**
- IBM Study on Supply Chain Transformation
 - **Mr. Brad Berkson (AT&L), lead**
- Business Management Modernization Program
 - **Ms. Joann Boutelle (OUSDC), lead**

Appendix D

Strategy: Outline for Secretary of Defense Strategic Planning Guidance

This appendix proposes an outline for the Secretary of Defense Strategic Planning Guidance (SPG).

Objective – Define strategic objectives, key priorities, risk tolerance levels, overarching assumptions and operational/organizing concepts that support the National Security Strategy and Policy and the execution of that strategy by Combat Commanders and other DoD components. The strategic direction contained in the SPG must provide the key, corporate level direction needed for the operational, enterprise, and capabilities planning processes. The objectives, priorities, risks and assumptions described in the SPG will drive the trade analysis conducted in the Enhanced Planning Process, which in turn will result in Joint Programming Guidance.

1. **Define National Security Strategy/Policy Requirements.** Provide a unified, outcome-focused strategic direction for Combatant, Functional and Component Commands.
 - a. Describe force employment concepts to achieve the objectives of the National Security Strategy, incorporate feedback from program execution--including Readiness Reporting (DRRS)--and identify needed changes to current program execution.
 - b. State strategic priorities, show integration of theater strategies and priorities, and provide a global focus that integrates theater and functional mission priorities.
 - c. Identify the joint capability categories that will provide a common framework and consistent definitions, support the assessment of programs on the basis of their contribution to joint capabilities, and allow the identification of trade areas to support gap analyses (essential for the first cycle, FY06).
2. **Identify ROM fiscal and other constraints.** The strategy, and the plans that support it, should be consistent with the resources expected to be available for the timeframe of the plans. The planning guidance should indicate, as specifically as possible, the fiscal and other resource constraints to be used in developing plans; it should also be the basis for DoD's business strategy. Any other constraints (e.g., political,

organizational) that directly affect planning processes should be highlighted.

3. Provide a framework for Enhanced Planning.

- a. Incorporate an assessment of the future geo-strategic security environment. The assessment should be consistent with the best projection of the capability and the methods of future adversaries to provide a baseline for all planning efforts. Key threat assumptions, such as weapon system proliferation rates, asymmetric application of low-tech equipment, and ability to attack information systems, should be included.
- b. Establish and specify strategy objectives (including the SecDef transformation policies and objectives).
 - i) Identify capability objectives that enable the strategy (e.g., defeat adversaries who can neutralize current/emerging stealth technology; target capital ships from 1000nm; deny APOD/SPOD access; neutralize satellites; disrupt SIPRNet; and target the United States or allies w/WMD).
 - ii) Identify the decisions desired, by capability category, for the time frame of the guidance and the analytical efforts required to support those decisions.
 - iii) Describe and prioritize desired near- and long-term capabilities and operational characteristics of the Joint Force and Components. Based on the results of the Enhanced Planning Process, capabilities should be quantified to the extent the strategy demands (e.g., deliver “x” amount of strike to “y” areas with 96 hours warning; control “x” facilities/airfields/ports within 96 hours; project “y” ground forces ashore to “n” nm within 10 days of warning; and perform forcible entry operations at the brigade level in x days without host nation support).
 - iv) Specify, by operational theater (CoCom AoRs), expected force postures to execute the strategy, including how regional partnerships should be factored into planning (including integrated global footprint and Security Cooperation Guidance).
 - ◆ Component roles should be indicated as appropriate (e.g., total strike capability should be “x percent ” by Naval forces in these AoRs, “y percent” by USAF; “z percent” of total ISR should come from space assets by 2010 in the following theaters...).

- v) Incorporate the decisions and priorities of the Nuclear Posture Review by Functional Mission Area (e.g., strategic forces, logistics, and intelligence).
 - ◆ The future size, readiness posture, and response times of nuclear deterrent forces.
 - ◆ The type and persistence required of ISR capabilities by operational theater.

- c. Identify the strategic concepts for planning future enterprise functions (e.g., work force strategy, business practices, and infrastructure). Provide the organizing principles and new concepts for future enterprise management. Those principles and concepts should be tied to concepts for future joint operations (JOCs) and incorporate specific priorities and goals of the Transformation Planning Guidance (TPG).
 - i) Identify strategic approach to workforce planning and management.
 - ◆ Identify criteria for utilization of military personnel, and the decision strategy for choosing between use of active and reserve component personnel.
 - ◆ Identify criteria for utilization of civilian employees rather than contractors.
 - ◆ Define, describe, and establish metrics for personnel management functions (including planning functions).
 - ii) Identify strategic approach to “overhead” support functions.
 - ◆ Identify strategic goals of central support functions.
 - ◆ Identify criteria for choosing among options.
 - iii) Identify strategic plan for such areas as bases, ranges, and housing.
 - ◆ Identify criteria for maintenance priorities, consolidations, closings, and new facilities.
 - ◆ Define, describe, and establish metrics for infrastructure management (including long-range planning).
 - iv) Identify strategic plan for acquisition enterprise operations.
 - ◆ Identify strategic approach (e.g., spiral development).
 - ◆ Identify acceptable levels of technological risk.

-
- d. Articulate risk tolerance. Risks are currently characterized as force management, operational, future and institutional. The planning guidance should state where and how much risk is acceptable in each risk area and theater or mission area. The SPG should indicate where we can afford to accept more risk or, conversely, where DoD needs to reduce risk. The trade analysis conducted in the Enhanced Planning Process will be conducted consistent with this guidance.
4. **Identify operational and organizing concepts for future Joint Force Operations to structure experimentation, research and development, and capability planning.** These concepts may come in the form of the JopsC, but they should provide the direction for development of new capabilities that may change the way the Joint force operates in the future. The concepts should incorporate the transformation goals and objectives of the TPG.

Appendix E

Enhanced Planning

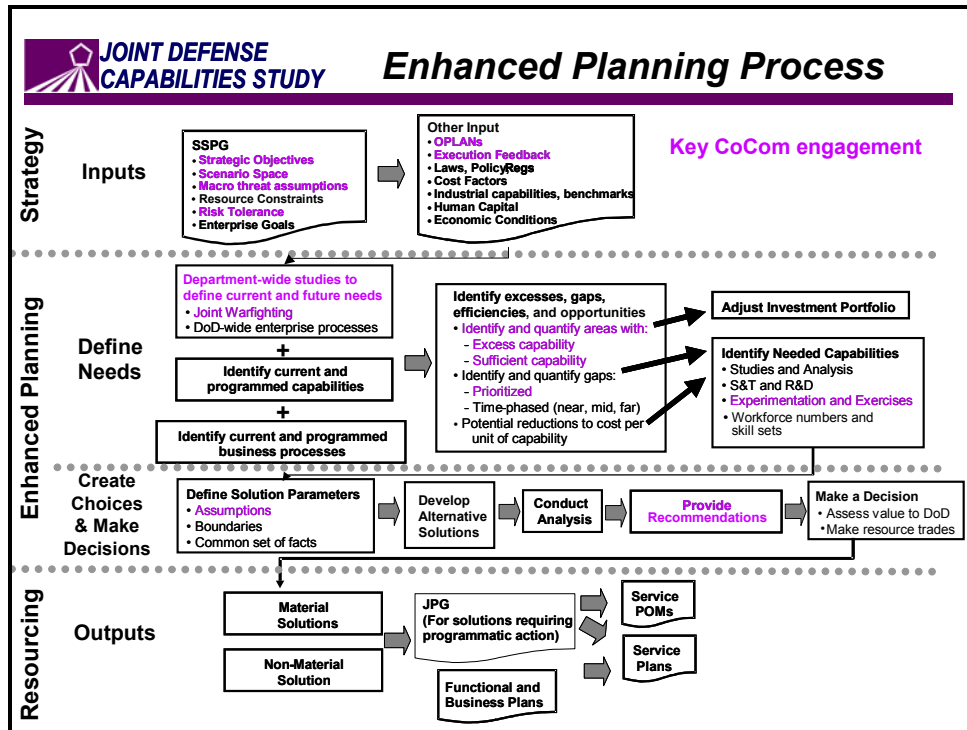

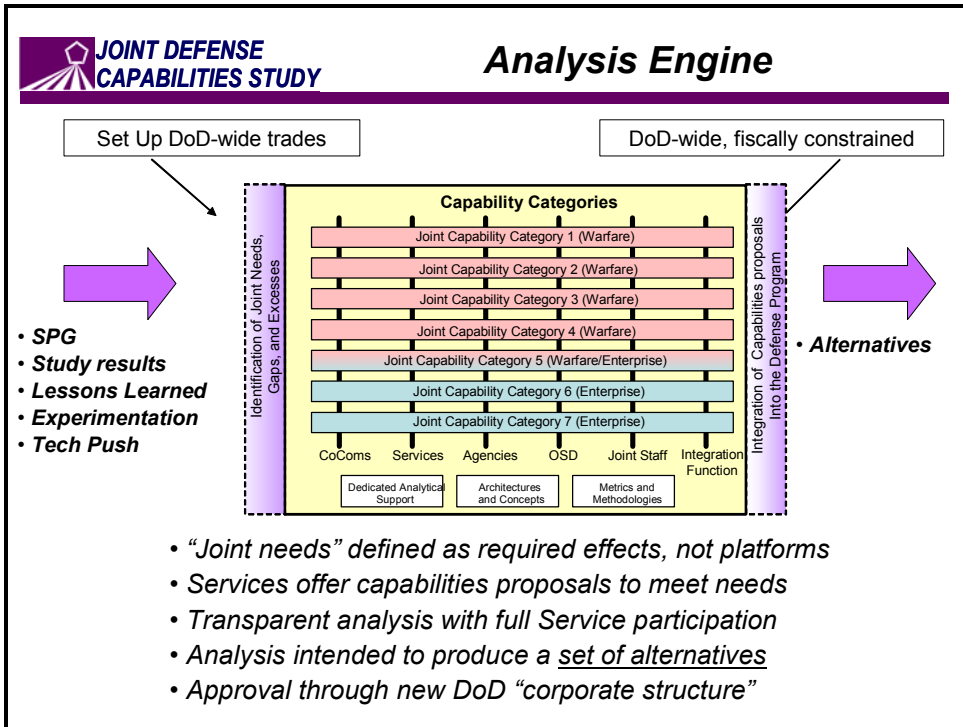

Appendix F

Capability Categories



**JOINT DEFENSE
CAPABILITIES STUDY**

Capability Framework

November 3, 2003

Pre-Decisional

“Flesh-out” the September 12th SLRG decision to develop joint capability categories. These categories should enable us to:

- Focus on outcomes and effects
- Manage and plan for capabilities
- Conduct trade analysis to determine best solutions
- Track performance and share information

Pre-Decisional

If you want to answer...

- What? How Much? When? Then...

At the Department level, you need to:

- Elevate the discussion above the platform and “single solution” level
- Communicate consistently, with a shared vision and common language
- Have a single set of facts and assumptions to guide analysis and decisions

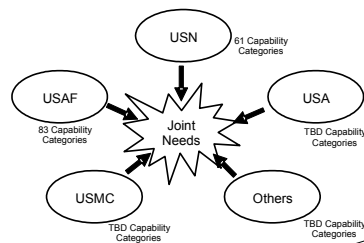

- Currently no linkage to commonly defined Joint capabilities
- Difficult to do cross-Service capability trades
- Services define Joint capability needs

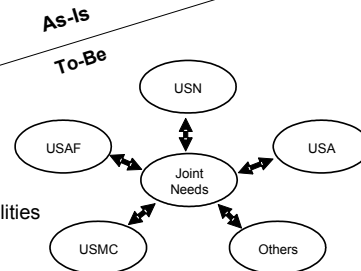

- Joint community defines Joint needs
- Allows Services to map to Joint capabilities
- Facilitates analysis by capability

Pre-Decisional



Capability Categories

Two Approaches

- Capability categories can be based on functions or operations
 - **Functional** categories focus on how military activities are to be enabled such as command and control, logistics, and force application.
 - **Operational** categories focus on military activities to be performed such as major theater war, nuclear war, special operations, etc.
- Functionally aligned categories:
 - Allows a fewer number of more enduring categories
 - Provides a basis for organization and covers warfighting *and* enterprise capabilities
 - Reduces redundant representation of platforms and systems
 - Better for capabilities planning or management functions
- Operationally aligned categories:
 - Provides the basis for conducting cross-Service trade analyses
 - Easier to link platforms and weapon systems to required tasks and missions
 - Better for translating CoCom needs into capabilities
 - Clearer link to an outcome/effects-based orientation

Both approaches are necessary to plan and manage the full spectrum of a capabilities-based approach to warfighting

Pre-Decisional



Functional Capability Categories

Basis for Management

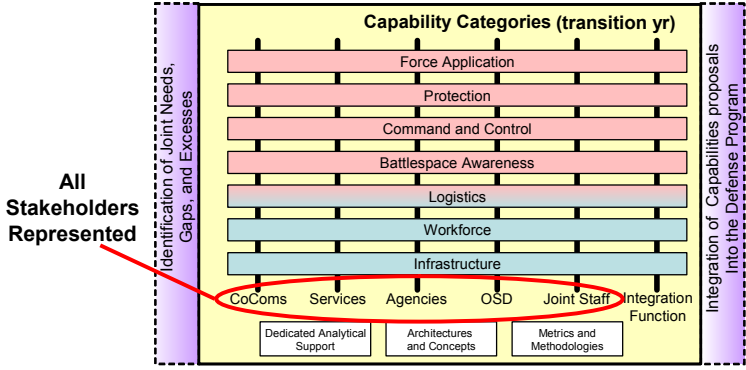

The diagram illustrates the 'Functional Capability Categories (transition yr)' as a series of horizontal bars representing different capability areas: Force Application, Protection, Command and Control, Battlespace Awareness, Logistics, Workforce, and Infrastructure. These are supported by a base of 'CoComs, Services, Agencies, OSD, Joint Staff, Integration Function'. Below this base are three support boxes: 'Dedicated Analytical Support', 'Architectures and Concepts', and 'Metrics and Methodologies'. The entire structure is framed by a dashed box with vertical text on the sides: 'Identification of Joint Needs, Gaps, and Excesses' on the left and 'Integration of Capabilities proposals into the Defense Program' on the right. A red oval highlights the 'CoComs, Services, Agencies, OSD, Joint Staff, Integration Function' base, with a red arrow pointing to the text 'All Stakeholders Represented' on the left.

- Experts organized to assess alternatives for joint capability needs
- Responsible for maintaining capabilities-based tools and methodologies:
 - Metrics, attributes, architectures, and concepts
 - Capabilities roadmaps
- Fewer, broader categories are needed to translate between Components, Interagency Agency and Coalition partners – a forum for collaboration

Pre-Decisional

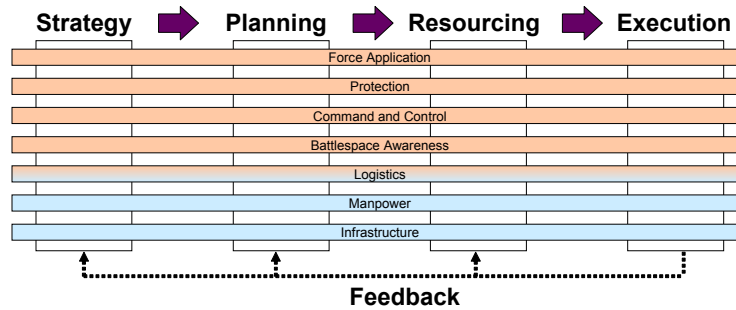

Capability categories track across processes, from Strategy to Execution

- A common structure for articulating joint capabilities
- A consistent message across the Department
- Clear lanes for roles and responsibilities
- A framework for capability assessments and trade-off analyses
- Supports senior leadership decision making on capabilities resourcing

Feedback informs decision makers throughout the process

Much greater number that change over time (CoCom driven)

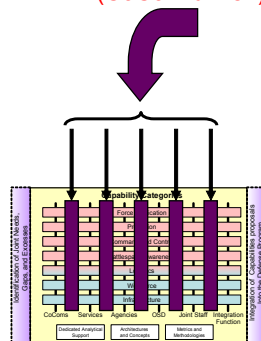

1. Deter adversaries and reduce the need for military force to achieve national objectives.
2. Prevent the initiation and escalation of armed conflict.
3. Increase the capability of allies/coalition partners to assist in achieving security objectives.
4. Defend the United States against enemy missile attack.
5. Protect DoD personnel, dependents, facilities, and installations from terrorist or other attacks.
6. Locate and identify the capabilities of potential military adversaries.
7. Locate and identify the capabilities of potential non-military adversaries.
8. Identify the intentions of potential military adversaries.
9. Identify the intentions of potential non-military adversaries.
10. Maintain the use of the sea and littorals for U.S. military objectives.
11. Maintain the use of the air for U.S. military objectives.
12. Maintain the use of space for U.S. military objectives.
13. Maintain the use of information and the electromagnetic spectrum for U.S. military objectives.
14. Deny the use of the sea and littorals to adversaries.
15. Deny the use of the air to adversaries.
16. Deny the use of space to adversaries.
17. Deny the use of information and the electromagnetic spectrum to adversaries.
18. Detect, locate, and destroy adversary WMD capability.
19. Locate and destroy hard and deeply-buried targets.
20. Deny adversaries the use of their installations, facilities, and infrastructure.
21. Locate, identify, and destroy moving and time-sensitive targets.
22. Seize and control terrain.
23. Deny adversaries sanctuary in urban areas.
24. Deny sanctuary to individuals and small groups.
25. Destroy or neutralize adversary military capabilities.
26. Control the behavior of noncombatants without the use of lethal force.
27. Deny sanctuary to adversaries intermingled with noncombatants.
28. Stabilize and maintain order in Nations and non-State areas.
29. Protect deployed forces from air, sea, space, land, and information attack.

- Operational capabilities are trade areas – required tasks and missions
- Every functional category contributes to each trade area
- When scenarios and concepts are applied, trades can be determined
- Experts from each function work together to determine trades

JOINT DEFENSE CAPABILITIES STUDY *Trade Areas and Functional Capabilities Working Together*

CoCom Demand Signal

For each *trade area*, scenarios and operating concepts are applied to determine the *functional* capability needs, gaps, and overlaps

Supply Decisions

Functional capability gaps/overlaps are translated into programatics for weapon systems, manpower, training, organizations, logistics, infrastructure, etc.

- Decisions are made in trade areas and are tracked along functional lines until they are translated into programatics
- Functional capability roadmaps are kept current as decisions are made

Pre-Decisional

JOINT DEFENSE CAPABILITIES STUDY *Trade Areas and Functional Capabilities A Notional Example*

Based on CoCom Operating Concepts and Agreed Upon Scenarios

Example: Deter potential adversaries from initiating nuclear hostilities (ensure US response can levy unacceptable consequences)

Sub-Category	Sub-Sub-Category	System/Resource
Nuclear	Unmanned	Minuteman III Trident D5 TLAM/N
Missile Defense	Homeland	TBD
National C2	Airborne	NAOC TACAMO
Surveillance	Missile Detection	DSP Satellites Ground Radars
Weapons Supply	Nuclear Warheads	SST
Active Duty	Nuclear Specialties	Operators Maintainers
Air Bases	Weapons Storage	Nuclear Bunkers

Ultimately, capability decisions must be translated into programatics

Pre-Decisional

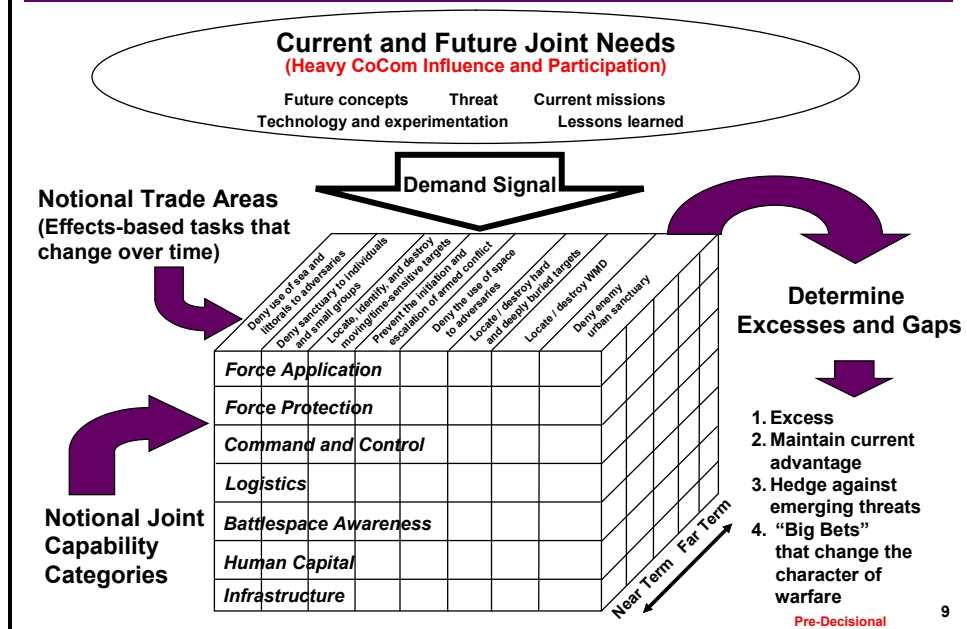

- Reach a common definition of "capability" and associated terms
- Identify capability categories and trade areas
- Develop a hierarchy of capability categories that support:
 - Cross Service trades
 - Strategy guidance articulation
 - Inclusion of operational and support capabilities
 - Gap analyses and evaluation of program contributions to the capability
 - Assessment of program execution
- Develop a compatible planning and programming framework
- Foster a "capabilities culture" that considers divestiture in tandem with initiatives; integrates risk; considers near and far term needs; is fiscally responsible

Appendix G

Resourcing

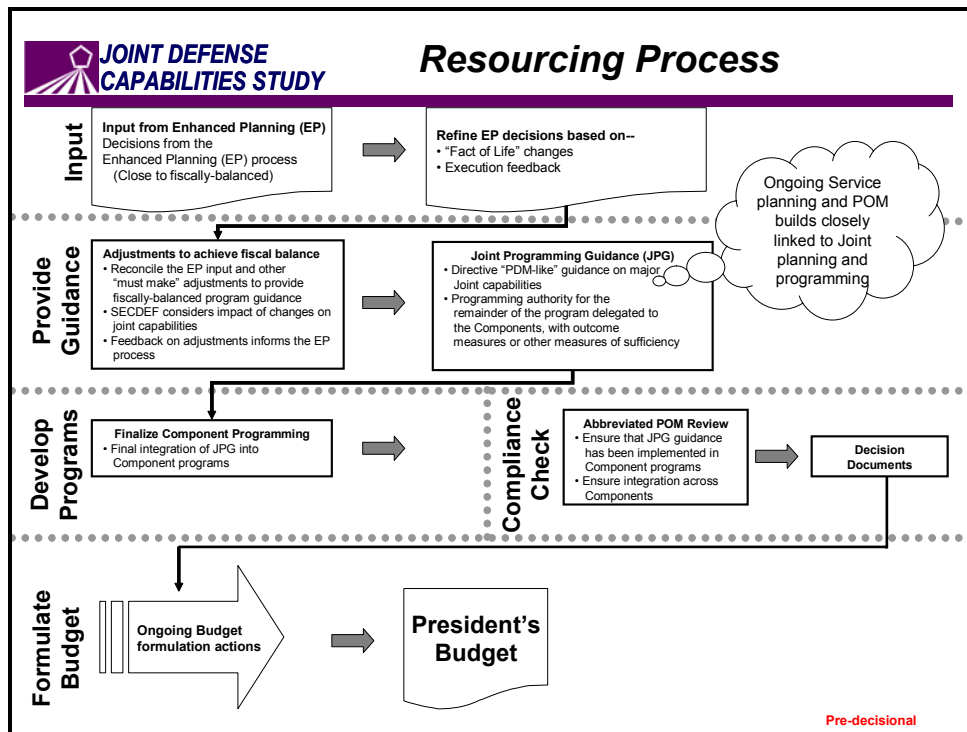

Outline for Secretary of Defense Joint Programming Guidance

Objective – To define Joint, Component, and CoCom programming objectives to support SecDef decisions recorded in the Strategic Planning Guidance (SPG) and developed in the Enhanced Planning Process. The Joint Programming Guidance (JPG) will provide Program Decision Memorandum-like directive guidance for selected major joint issues. It will delegate authority to develop the remainder of the program to the Components and CoComs, with associated performance measures and metrics.

1. **Implementation of the Strategic Planning Guidance.** The SPG is a multi-year document. This section of the JPG will summarize the objectives outlined in the SPG that are to be addressed in the current programming cycle and identify any issues associated with key SPG objectives that will not be accomplished in this cycle.

-
- a. **SPG Objectives Addressed in the Programming Guidance.** This section will identify SPG objectives to be addressed in the current programming cycle, whether the capability will be fully or partially addressed, and the rough costs associated with providing the specified level of capability.
 - b. **SPG Objectives Not Addressed in the Programming Guidance.** This section will identify SPG objectives that will not be addressed in the programming guidance and the reasons for not addressing them.
 - c. **Risk Assessment.** This section will assess the risk associated with the total program for this cycle and compare it to the risk guidance in the SPG.
2. **Directive Guidance for Joint Capabilities.** This section will provide PDM-like detail to implement the decisions made by the SecDef during the enhanced planning process.
 - a. **Organization.** This section will be organized in accordance with the capability categories and issues in the SPG.
 - b. **Content.** This section will specify which Component will execute the program, the quantities of personnel or systems to be provided, and milestones for the delivery of the capability.
 3. **Guidance for Delegated Programming.** This section will provide guidance on the portions of the program that are delegated to the Components and CoComs. The delegated programming will contain performance measures or measures of sufficiency for capabilities.
 - a. **Organization.** This section will be organized in accordance with the capability categories and issues in the SPG.
 - b. **Content.** This section will specify the outcome or level of effort required, and identify how compliance or success will be measured.
 4. **Reconciliation of Guidance and Resources Available.** This section will demonstrate that the sum of the funding requirements imposed by the JPG, and SPG when applicable, is less than or equal to the resources available for the programming period.

Appendix H

Performance

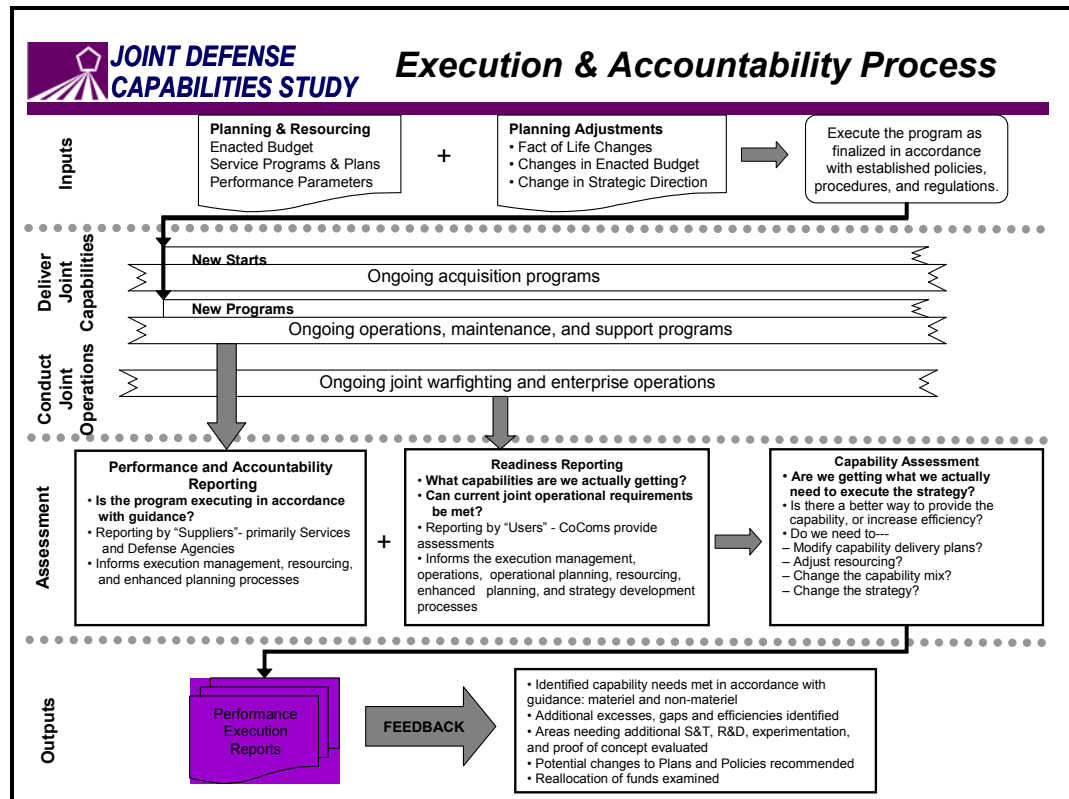

Outline for Secretary of Defense Performance Assessment Process

Objective – To integrate user and provider assessments of current capabilities and risks in order to provide an overall review of current and planned future capabilities relative to the Strategic Planning Guidance (SPG) and the Joint Programming Guidance (JPG); determine whether those capabilities are sufficient to execute the strategy; identify capability and resourcing issues for discussion by the Strategic Planning Council (SPC); and inform decisions to be incorporated in subsequent planning and programming guidance.

1. **Format.** The performance assessment process will take two forms: briefings and a written annual report. Both forms will be comprehensive; that is, each will include all capabilities and activities in the Department. They will be organized around the capabilities categories and objectives outlined in the SPG and addressed in the JPG.

-
- a. One form of assessment will be periodic briefings to the SPC to support regular internal management review. The briefings will be based on capability metrics used in the Enhanced Planning Process.
 - b. The second form of assessment will be an annual Performance Assessment Report (PAR), intended for both external and internal audiences. This report will summarize overall performance and relate it to the Department's overall goals. It will be at a high level of aggregation and based on a Balanced Scorecard approach.
2. **Reporting responsibilities.** Assessments will be made by an independent assessor, possibly supported by a small staff. The role of the assessor will be to (1) integrate input concerning current capabilities that is provided by Combatant Commanders, Chairman of the Joint Chiefs of Staff, Service Chiefs, Principal Staff Assistants and Agency Heads, and analysis engine team leaders; (2) determine whether the capabilities are being delivered as expected and as directed in the JPG (in both delegated and directive sections); and (3) decide whether the total capabilities are sufficient to meet the strategy.
- a. Combatant Commanders report to the assessor as to whether the capabilities they have are sufficient to meet their Joint Operational Requirements.
 - b. Chairman of the Joint Chiefs of Staff reports the capability of the United States as compared with those of its potential adversaries; this assessment is made for all warfighting capabilities.
 - c. For enterprise capabilities, the PSA may be an Under Secretary or another designated person (such as the DoD Human Capital Officer for workforce capabilities and the Chief Acquisition Executive for acquisition capabilities). The PSAs report whether the current levels and expected longer term changes in enterprise capabilities are sufficient to support the strategy enunciated in the SPG and JPG for enterprise capabilities. They also report whether any efficiencies or capabilities they are directed to provide under the Directed Programming Guidance are being achieved as specified in the JPG. Finally, the PSAs, together with Agency Heads, supply all input not provided elsewhere, so that the assessor receives reports concerning the totality of DoD spending.
 - d. The Service Chiefs report whether the capabilities they are directed to provide under the Directed Programming Guidance are being achieved as specified in the JPG. They also report on the sufficiency measures specified in the delegated guidance section of the JPG.

- e. The analysis engine team leaders report on the results of their evaluations of the achieved levels of capabilities in their areas of responsibility.

3. Briefings to the Strategic Planning Council

- a. The assessor will periodically brief the SPC on (1) whether the program is executing in accordance with guidance, (2) what capabilities are being provided, and (3) whether those capabilities are sufficient to support the strategy. The assessments of capabilities will be based on the metrics and measures (objective and subjective) used in the SPG and JPG, and the requirements set in those documents.
- b. One SPC briefing each year will be comprehensive (include all capabilities and risk) and occur in May, in time to inform SPC review and comment on the current JPG. This briefing will also serve as a major input into the next SPG. The SPC and the participants in the Enhanced Planning Process then must decide whether to modify capability delivery plans (including resourcing), change the capability mix, or change the strategy.
- c. The briefings to the SPC that occur between the annual comprehensive assessments will focus on selected capabilities and be staggered so that all important issues are reviewed over the course of a year. The briefings will be based on the stakeholder reports provided for the annual comprehensive brief, as well as any more recent information that is readily available (e.g., through execution reviews).

4. Annual Performance Assessment Report

- a. This report, which will be transmitted by the Secretary to Congress and the public, will summarize the strategy and capabilities of the Department of Defense. It will cover accomplishments of the previous fiscal year's budget, in capability terms.
- b. The PAR will explicitly link the Quadrennial Defense Review (QDR) to the SPG and JPG.
- c. The PAR will follow a balanced scorecard approach for major goals, with an overall determination of "red-yellow-green," relative to the guidance in the SPG and JPG. It almost certainly will not use the metrics and measures of each capability category, and may not assess capability categories individually.

After full transition to the new process, the PAR will become the basis of the Annual Defense Report transmitted to Congress every January.

Appendix I

Steering Group Members

Mr. William Haynes
Department of Defense General Counsel

Mr. Peter Geren
Special Assistant to the Secretary of Defense

Mr. Ken Krieg
Special Assistant to the Secretary of Defense
Director, Program Analysis and Evaluation

Mr. Larry Lanzillotta
Deputy Under Secretary of Defense (Management Reform)
Principal Deputy Under Secretary of Defense (Comptroller)

Mr. Philip Grone
Principal Deputy Under Secretary (Installations and Environment)
Office of the Under Secretary of Defense (Acquisition, Technology and Logistics)

Ms. Jeanne Fites
Deputy Under Secretary of Defense (Program Integration)
Office of the Under Secretary of Defense (Personel and Readiness)

Mr. Brad Berkson
Special Assistant to the Under Secretary of Defense (Acquisition, Technology and Logistics)

Lieutenant General James Cartwright
Director for Force Structure, Resources, and Assessment (J-8)
Joint Staff

Lieutenant General James L. Lovelace
Director of the Army Staff
United States Army

Lieutenant General Benjamin S. Griffin
Deputy Chief of Staff, G-8
United States Army

Mr. Pat Tamburrino
Assistant Deputy Chief of Naval Operations (Resources, Requirements and
Assessments) (N8B)
United States Navy

Major General Jim Battalini (USMC)
Director, Expeditionary Warfare Division (N75)
United States Navy

Rear Admiral Kevin Cosgriff
Director, Warfare Integration and Assessment Division (N70)
United States Navy

Mr. Michael Dominguez
Assistant Secretary of the Air Force
(Manpower & Reserve Affairs)
United States Air Force

Major General Ron Bath
Director, Strategic Planning (AF/XPX)
United States Air Force

Mr. Joe Masciarelli
Assistant Deputy Commandant for Programs and Resources (P&R)
United States Marine Corps

Dr. Tom Allen
Former President
Military Operations Research Society

Mr. Tom Morehouse
Consultant
Institute for Defense Analysis

Mr. John Tillson
Senior Analyst
Institute for Defense Analysis

Dr. Kathy Webb
Policy Sciences Group Manager
RAND Corporation

Mr. Chris Williams
Consultant
Center for Strategic and International Studies

Appendix J

Study Team Members

The Honorable E.C. Aldridge, Jr.
Study Leader

Ms. Mary Margaret Evans
Executive Director
Office of the Under Secretary of Defense (Acquisition, Technology & Logistics)

Mr. Robin Farley
Office of the Under Secretary of Defense (Comptroller)

Ms. Judy Fernandez
Office of the Under Secretary of Defense (Personnel & Readiness)

Dr. Vance Gordon
Office of the Secretary of Defense (Program Analysis & Evaluation)

Mr. Frank Leaming
Directorate of Administration and Management

Mr. Steve Reeder
United States Joint Forces Command

Colonel Mike Morgan
Joint Staff, J-8

Lieutenant Colonel Jim Mathis
United States Army

Captain Wilhelm A. Hansen, Jr.
United States Navy

Colonel Robert Suminsby, Jr.
United States Air Force

Colonel Nathan Webster
United States Marine Corps

Mr. Yvonne Whichard
American Telephone & Telegraph

Mr. Rick Jackson
Logistics Management Institute

Ms. Elaine Simmons
Logistics Management Institute

Mr. Simon Hernaez
Logistics Management Institute

Mr. Rick Wallace
Science Applications International Corporation

Appendix K

Chronology/Decision Points

Date	Major Event
03 APR 03	SecDef commissions Mr. Aldridge to conduct study
19 MAY 03	Study Team formed – study begins
17 JUN 03	As-is/end state briefing presented to Steering Group
19 JUN 03	Mr. Aldridge briefs SecDef on as-is/end state
20 AUG 03	Mr. Aldridge briefs SecDef on the Study Team's proposed process
10 SEP 03	Study Team presents process brief to the Steering Group
12 SEP 03	Mr. Aldridge presents proposed process to the Senior Leader Review Group
14 SEP 03	Overarching memo recording the agreements made during the SLRG is coordinated throughout DoD
19 OCT 03	Study Team presents process brief to OPSDEP Tank
23 OCT 03	Mr. Aldridge meets with SecDef to discuss the status of the overarching memo and level one alternatives
30 OCT 03	Capabilities-based processes brief presented to Defense Science Board
31 OCT 03	Mr. Aldridge presents capabilities-based processes brief to the Senior Leader Review Group
31 OCT 03	Secretary Rumsfeld signs directive to implement specific steps towards end state process for POM 06
22 NOV 03	Mr. Aldridge submitted draft final report along with his final recommendations to SecDef
JAN 04	Final report published.

Appendix L
Organizational Alternatives—First Order



Alternatives Brief

Part I – First Order Changes

October 28, 2003

Pre-decisional

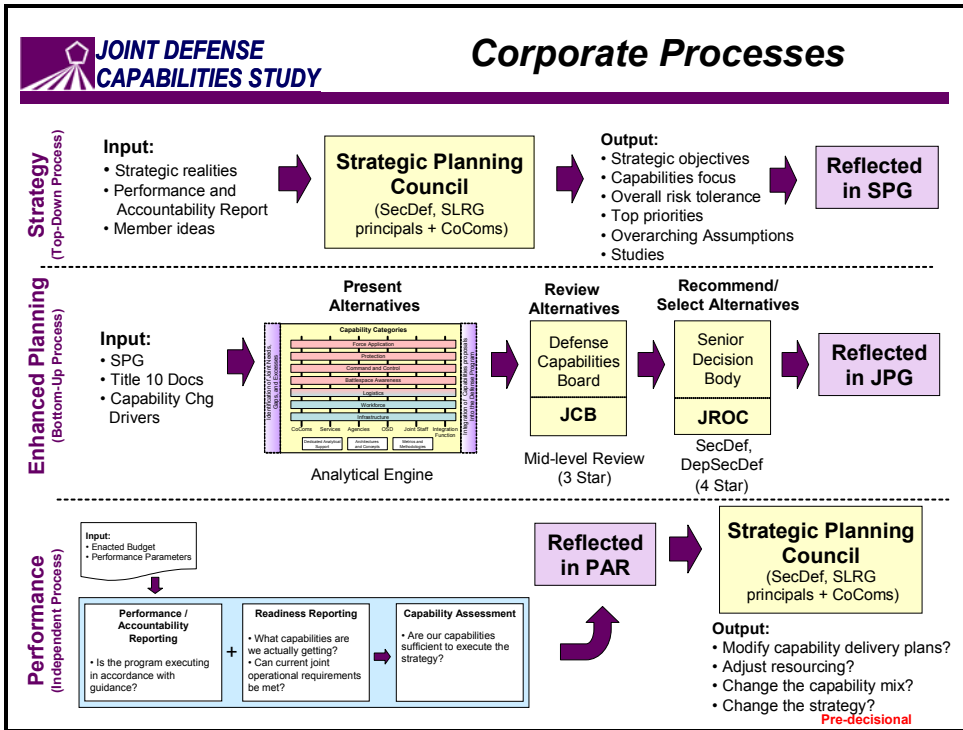
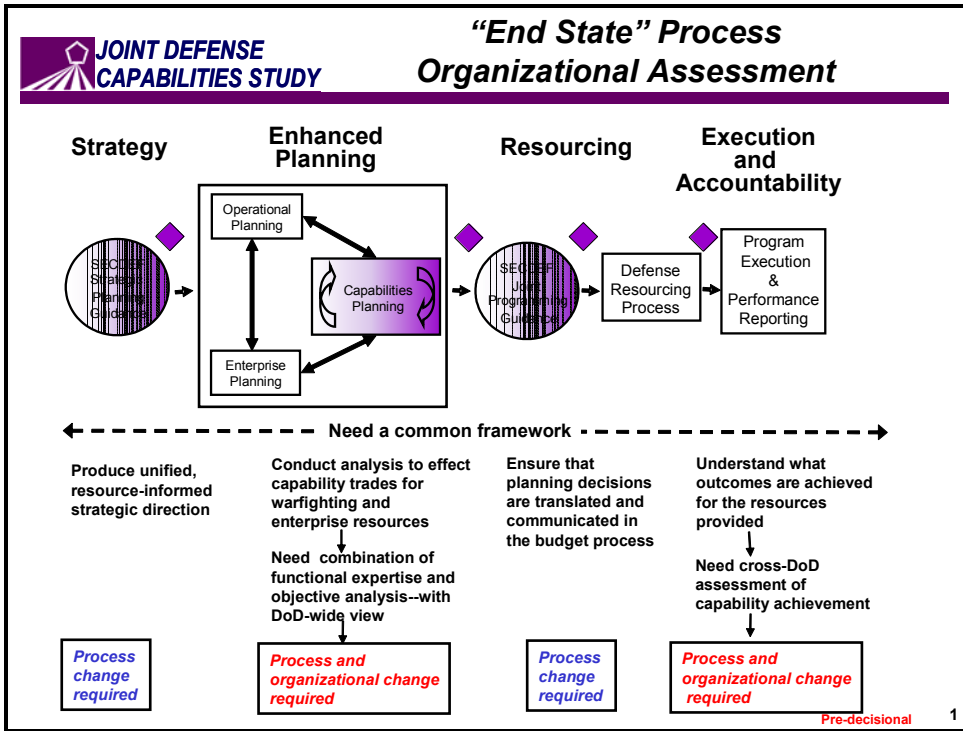

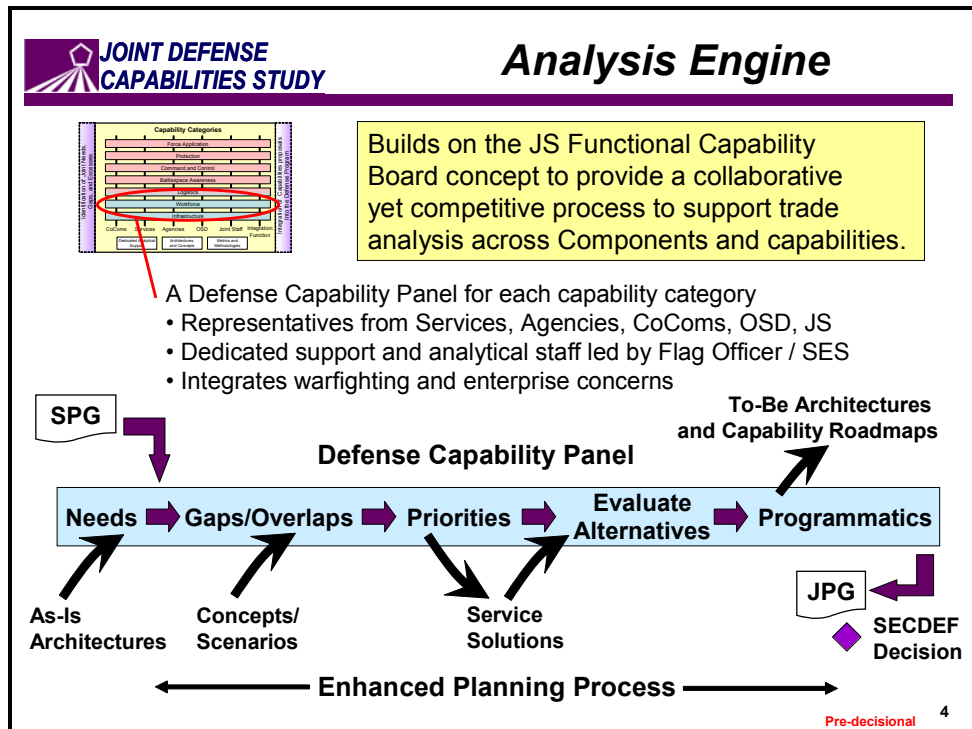
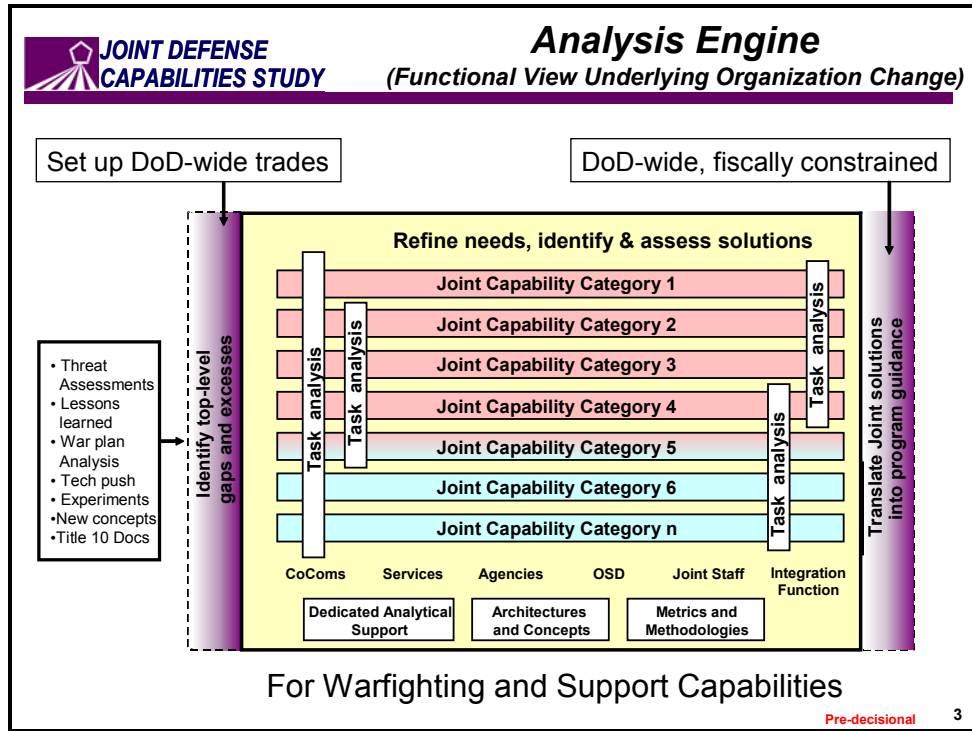

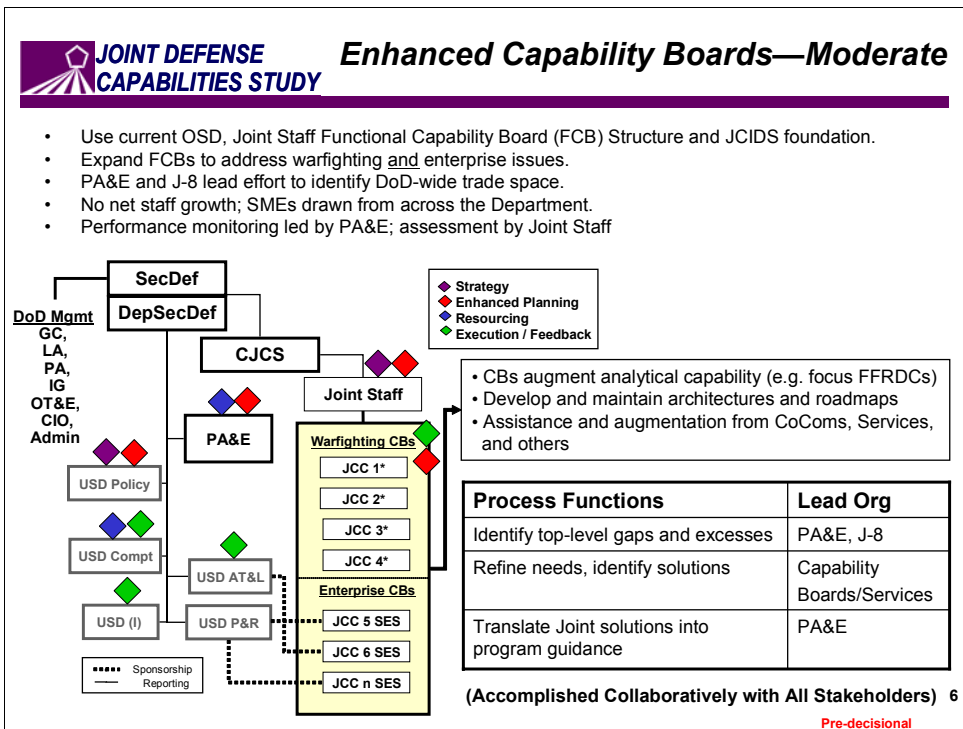
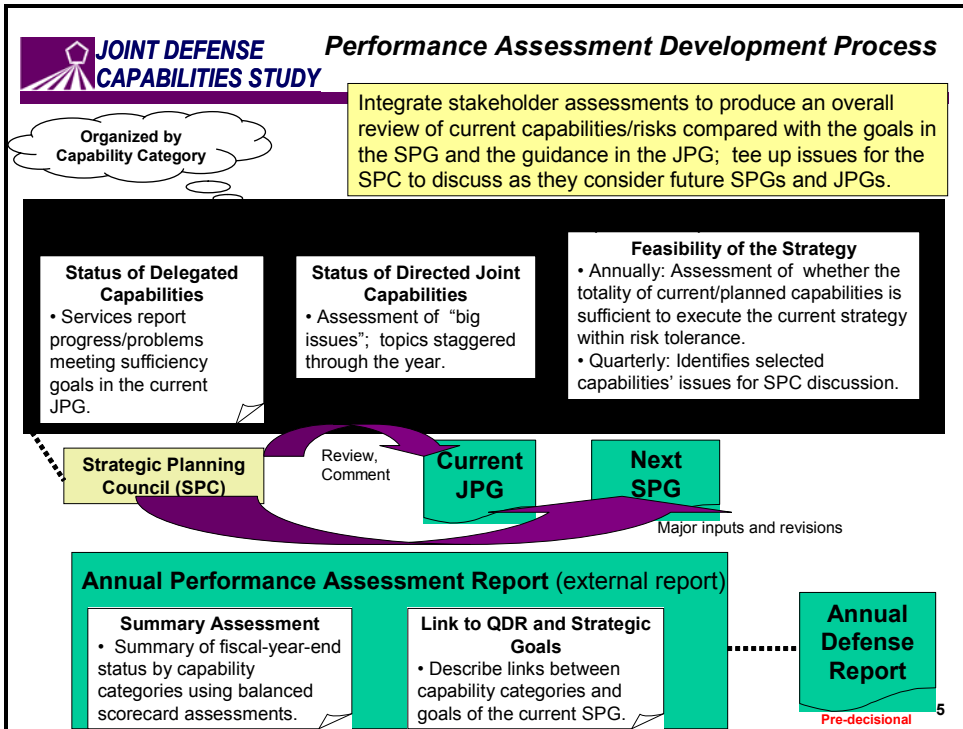

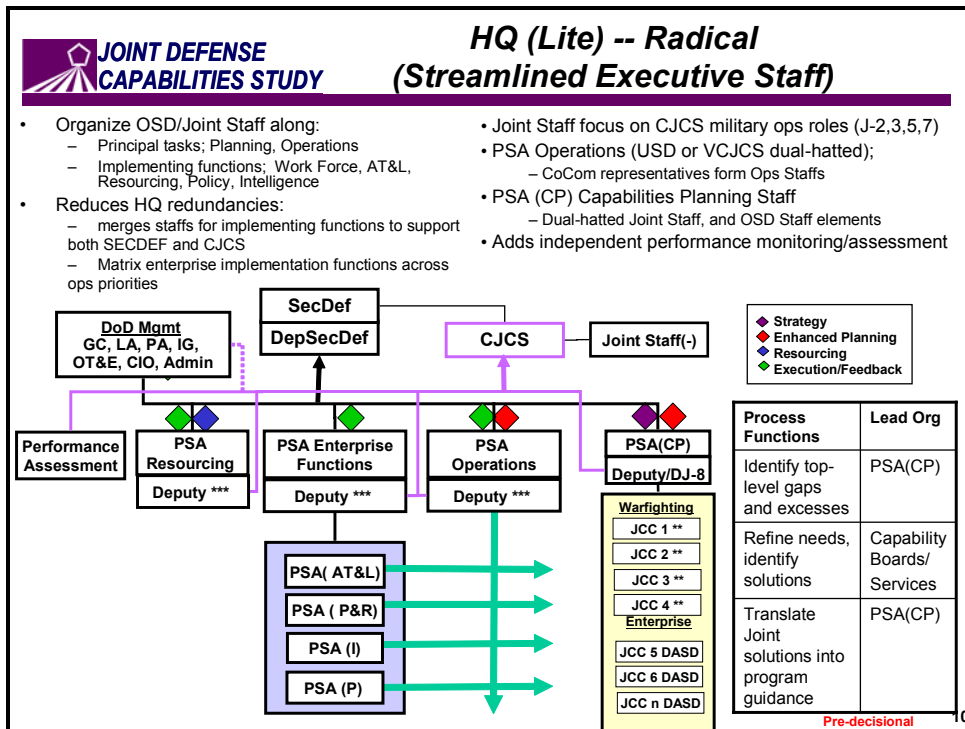
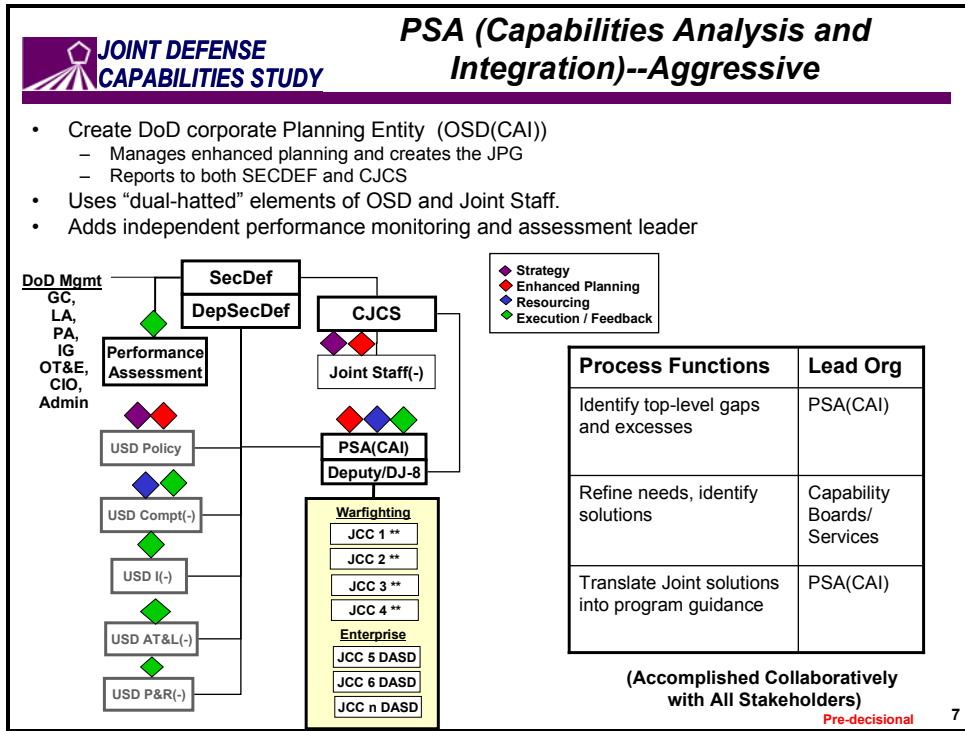

General Observations

Basic characteristics of all three options--

- Roles of SECDEF, CJCS and Services do not change
- Top-level needs, gaps, and excesses are identified by an organization with a DoD-wide view
- Consideration of both warfighting and enterprise capabilities
- Collaborative effort with all stakeholders, including CoComs and Services

Pre-decisional

Appendix M
Organizational Alternatives—Second Order

Alt 1 - Moderate – Multiple JPE Concept

Description: Establish Joint Program Executives (JPE) for each of the designated Joint Programs.

- Designate Joint Program Executives (JPE) (reports through the Service Acquisition Executive), one for each Joint Capabilities Category (JCC), through the Joint Capability Boards (JCB) and the Defense Acquisition Board (DAB).
- Provide input to the Defense Acquisition Executive (DAE) (USD (AT&L)) on current joint in-development, in-production programs. This links the acquisition process to joint needs planning and development.
- Resources pulled from the Components for Joint Programs (JPG directed guidance) with oversight by JPE, reporting to DAE. SAEs retain resources for Service programs.
- DAE, with JPE and SAE input, develops a comprehensive acquisition strategy/plan which leverages the JCIDS process to clearly articulate goals/objectives to meet departmental joint capability needs. A comprehensive acquisition strategy allows for immediate, near term and long term programmatic planning to meet joint capability needs.
- Transform the Defense Acquisition Executive Summary (DAES) into a virtual, cross service process to allow for Department wide management across capability categories and within specific platforms. This DAES transformation permits the establishment of a cross cutting DAB.

Pros:

- Increased interoperability and material solutions execution due to capability focused vice platform centric planning and programming.
- Improved planning and coordination to meet joint capability needs.
- Improved efficiency in defining/delivering joint systems due to a better connectivity between "requires" and "acquires," as well as a more focused planning and upfront resourcing for joint programs.

Cons:

- Apportionment of resources specifically for joint programs could create gaps.
- Would enable but not ensure Service cross trade.
- Still dependent on existing Service or Agency to execute Joint Programs.

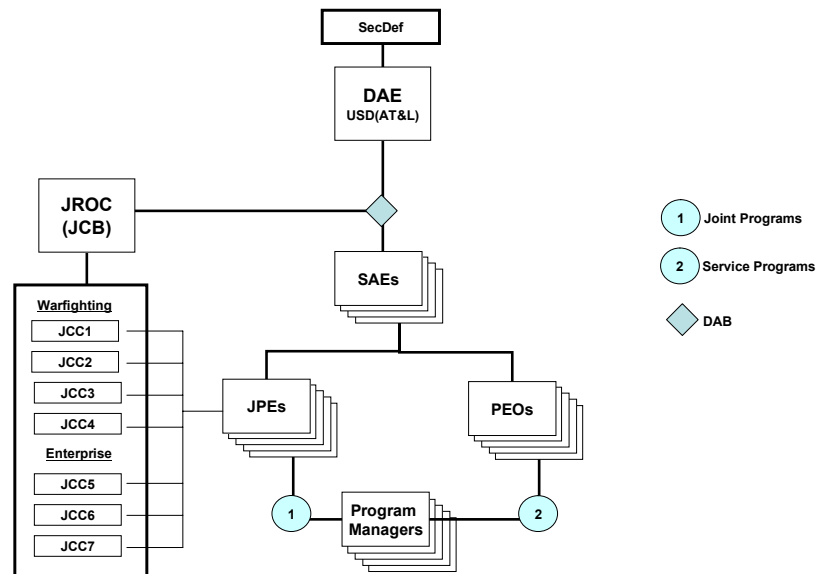



Enterprise Planning - Acquisition

Alt 2 – Aggressive – Single JAE Concept

Description: Establish a single Joint Acquisition Executive with oversight and decision authority on all joint developmental and in-production programs.

- JAE and SAEs, through JCB/DAB, provide input to the DAE on current joint in-development, in-production programs. This provides a direct link with central oversight to the acquisition process for joint needs planning and development.
- Acquisition resources for joint programs managed by the JAE would be supported by expanding the responsibilities of a selected acquisition agency to act as the JAE field activity. An appropriate portion of Component organizations would be integrated into this joint entity.
- DAE, with JAE and SAE input, develops a comprehensive acquisition strategy/plan which leverages the JCIDS process to clearly articulate goals/objectives to meet departmental joint capability needs. A comprehensive acquisition strategy allows for immediate, near term and long term programmatic planning to meet joint capability needs.
- DAB transformed along capability categories to align cross cutting joint capabilities, e.g., aircraft carrier command and control would be managed by the JAE, while the overall program is managed by the Navy.

Pros:

- Increased interoperability and material solutions execution due to capability focused vice platform centric planning and programming.
- Improved planning and coordination to meet joint capability needs through a single JAE.
- More efficiency in defining/delivering joint systems due to a better connectivity between “requires” and “acquires,” as well as a more focused planning and upfront resourcing for joint programs.
- Creates an execution arm for joint capabilities with a field activity to manage joint programs without creating a new organization.

Cons:

- Loss of authority by Components. Services may argue this usurps some of their Title X authority.

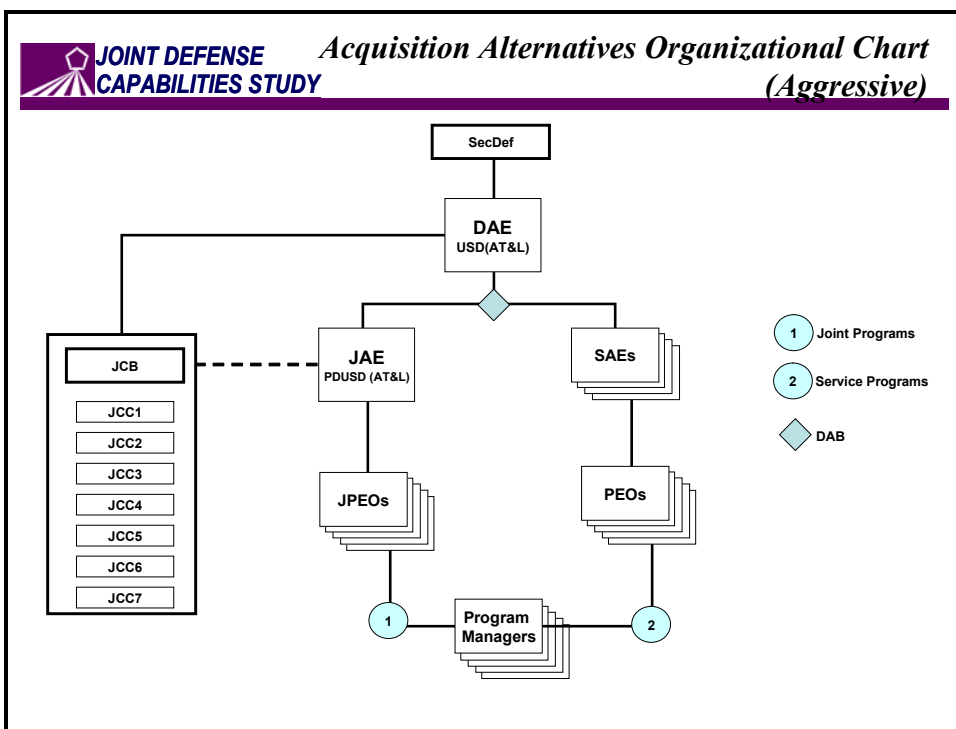

Alt 3 – Radical – Multiple CAE Concept

Description: Establish Capabilities Acquisition Executives (CAE) for each of the established Joint Capabilities Categories. The CAE would have oversight and decision authority on all Defense developmental and in-production programs.

• CAEs, through JCB/DAB, provides input to the DAE on current in-development, in-production, S&T and experimental programs. Acquisition process, management and structure directly support DoD capability needs development. All acquisition resources controlled by CAEs for their respective capability categories. As with the aggressive alternative, a joint entity or field activity would be established to support the CAEs.

• DAE, with CAE and SAE input, develops a comprehensive acquisition strategy/plan which leverages the JCIDS and Service unique requirements to clearly articulate goals/objectives to meet departmental capability needs.

• In addition to establishing an "expanded DCMA" as responsible for joint requirements acquisitions, establish an Agency which has oversight for Service Program Executive Offices (SPEOs). The SPEOs would manage ACAT I and II programs, through the Service Acquisition Executives.

Pros:

- Development of a comprehensive and seamless departmental S&T through acquisition system complete with resources and authority.
- Increased interoperability and material solutions execution of all DoD warfighting capabilities.
- Acquisition planning uniquely designed to meet DOD capability needs.
- Improved efficiency in defining/delivering joint systems due to a fully integrated system of "requires" and "acquires," as well as a more focused planning and upfront resourcing for joint programs.

Cons:

- Compete realignment of acquisition structure.
- Centralization under single acquisition executive could cause loss of focus on support programs.
- Loss of Service control of program development.

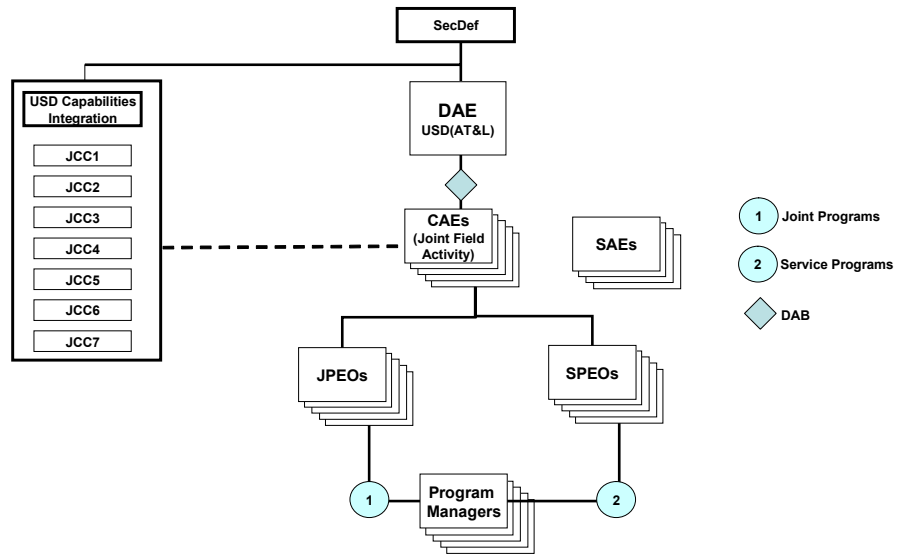



**JOINT DEFENSE
CAPABILITIES STUDY**

Enterprise Planning – RDT&E

Alt 1 - Moderate – Coordinated Investment

Description: Establish through DDR&E, a coordinated investment strategy that would support the Joint Capabilities Categories and provide information and oversight of RDT&E programs.

- Section 913 of the National Defense Authorization Act for FY2000 required SECDEF to conduct a performance review of the relevance of the work performed by DoD labs. Additionally, it required DoD to develop a single performance review process, applicable to all military departments, for rating the quality and relevance of the work performed by DoD labs. This proposal assumes full implementation of recommendations from Section 913 studies including a performance review process.
- Service S&T Executives organize to support Joint Capabilities Categories (JCC). This would more closely link technology development to the acquisition process and to COCOM generated joint needs planning and development.
- Develop a process to allow effective transition from S&T to acquisition. Process would include formal, binding agreements between S&T sources and specific program offices, as well as transitional funding managed by DDR&E to support the transition. (BA1-4 is S&T and managed by the S&T community, BA5-7 is R&D managed by acquisition and T&E managed by the DOT&E community)
- Realign ACTD funding process to DoD budget cycle to make transition to acquisition more efficient by using investment funds managed at OSD.
- Fully implement the authorities of the Defense Test Resource Management Center (DTRMC), created by the 2003 National Defense Authorization Act (NDAA) for oversight of T&E policy, processes, personnel and infrastructure. The NDAA charts the DTRMC Director with producing a "Strategic Plan" and certifying the "adequacy" of T&E operating and maintenance budgets. Incentivize T&E organizations to get involved earlier in the acquisition cycle to speed delivery and reduce cost.

Pros:

- Development of a comprehensive DoD S&T strategy that would be capability based but Component driven.
- Better transition of technology from S&T to acquisition and maximize the S&T and T&E investment through a single review process.
- No legislation required.

Cons:

- Impact of improved processes and oversight would not be fully realized if Components still own the resources.

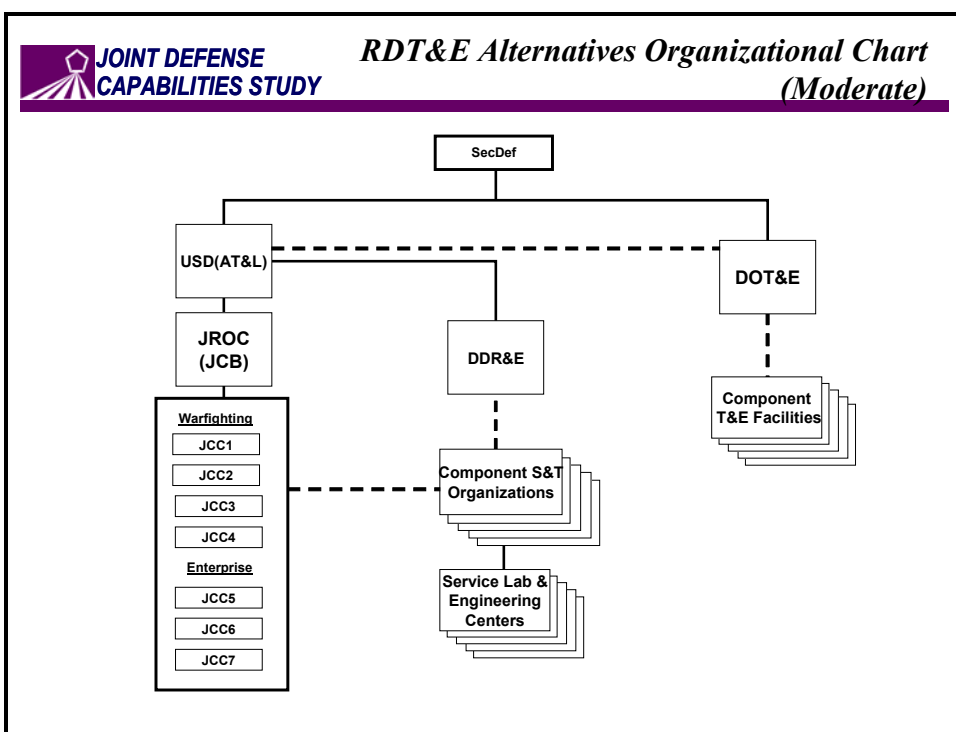

Alt 2 – Aggressive – Centralized Funding and Centers of Excellence

Description: Change flow of RDT&E resources through Defense Technology Executive, Defense Acquisition Executive and DOT&E directly to the Service S&T/T&E agencies vice through the Services. Establish Centers of Excellence within the current DoD Lab structure that would concentrate S&T and R&D investment.

- RDT&E resources centrally managed by the JAE, SAE's and DTE in an IPT process to provide innovation through competition and seamless transition through all phases of development to sustainment. Technology Readiness Levels would be uniformly enforced to ensure appropriateness of S&T vs. R&D funding and ACTDs would be fully integrated into the process. Process would include coordinated S&T investment by representation on each of the capability teams promoting transition funding to spiral technology through R&D directly into joint and Service programs.

- Centers of Excellence would be established within the current DoD/Service lab resources (including the Universities doing Basic Research) to concentrate S&T and R&D efforts in specific areas. COE's could also rotate workforce for professional development and compete for "best of breed" decisions. They could do both S&T work for the DTE and R&D work for the JAE's and SAE's. (COE's would be challenged to present proposals for different governance option such as Federal corporations or Government owned/contractor operated entities that are more conducive to broadening the business base.)

- T&E resources would be managed through the DTRMC under the auspices of DOT&E. Note: Developmental testing is done by the acquisition community. Incentivize T&E community to get involved earlier to speed delivery and reduce cost.

Pros:

- Development of a comprehensive DoD S&T strategy that would be capability based and centrally managed (JWSTP recently restructured along capability categories).
- Maximize the S&T investment and reduce duplication through a single review and allocation process and better transition of technology from S&T to acquisition through an IPT process linking capabilities, technology and acquisition.
- Alignment with COCOM/JCB priorities would provide checks and balances needed to compensate for DTE "special interests".

Cons:

- S&T would be centrally funded but R&D funds would still be allocated to the JAE's and SAE's.
- Although Component S&T organizations would be centrally funded for programs, infrastructure costs would remain the responsibility of the Components.

**RDT&E Alternatives Organizational Chart
(Aggressive)**

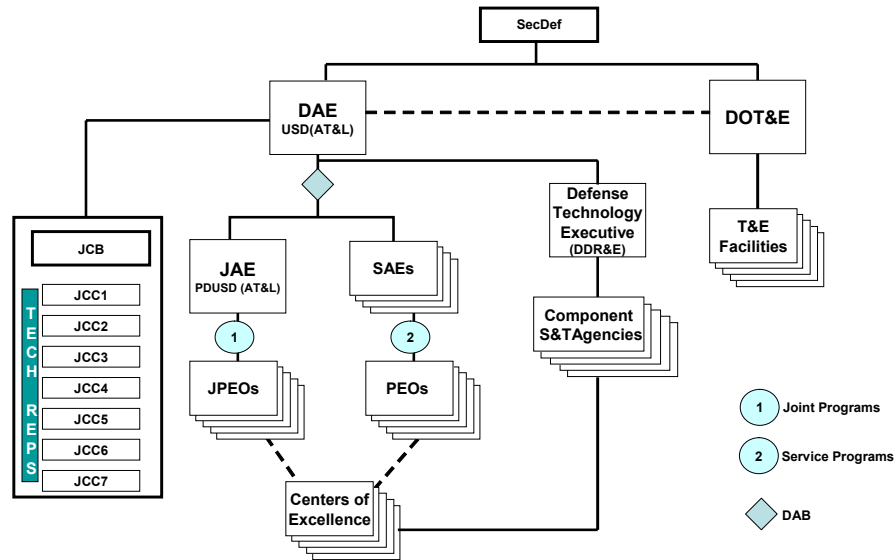



Enterprise Planning – RDT&E

Alt 3 – Radical – Central DoD Lab System

Description: Establish a centralized DoD Lab system (for S&T and R&D) owned and operated by a Defense Technology Executive who would be responsible for delivering technology to the Capabilities Acquisition Executives. DOT&E would own and operate T&E facilities.

- RDT&E resources centrally managed by the CAEs and DTE in an IPT process to provide innovation through competition and seamless transition from basic research to sustainment. Technology Readiness Levels would be uniformly enforced to ensure appropriateness of S&T (6.1-6.3) vs. R&D (6.4-6.5) funding and ACTDs would be fully integrated into the process. Process would include coordinated S&T investment by representation on each of the capability teams promoting transition funding to spiral technology through R&D directly into programs.
- Centers of Excellence would be established within a central lab system to concentrate S&T and R&D efforts in specific areas. Although specialized, COE's could invest in several areas to provide competition for "best of breed" decisions. (COE's would be challenged to present proposals for different governance option such as Federal corporations or Government owned/contractor operated entities that are more conducive to broadening the business base.)
- A single Office of Research with a Defense Research Lab would manage/execute all basic research for DoD including University research.
- T&E resources would be managed through the DTRMC under the auspices of DOT&E and they would be involved from Milestone A through deployment.

Pros:

- Development of a comprehensive and coordinated DoD RDT&E strategy complete with authority, resources and infrastructure to better support DoD warfighting capabilities .
- Spiral development of technology uniquely designed to meet DOD capability needs.

Cons:

- Compete realignment of RDT&E structure.
- Loss of Component control of RDT&E resources.
- Legislative changes required to authorize a DOD Office of Basic Research and Lab, alternative governance charters for FedCorps or GO/CO's, and a change in reporting authority of DTE (DDR&E).

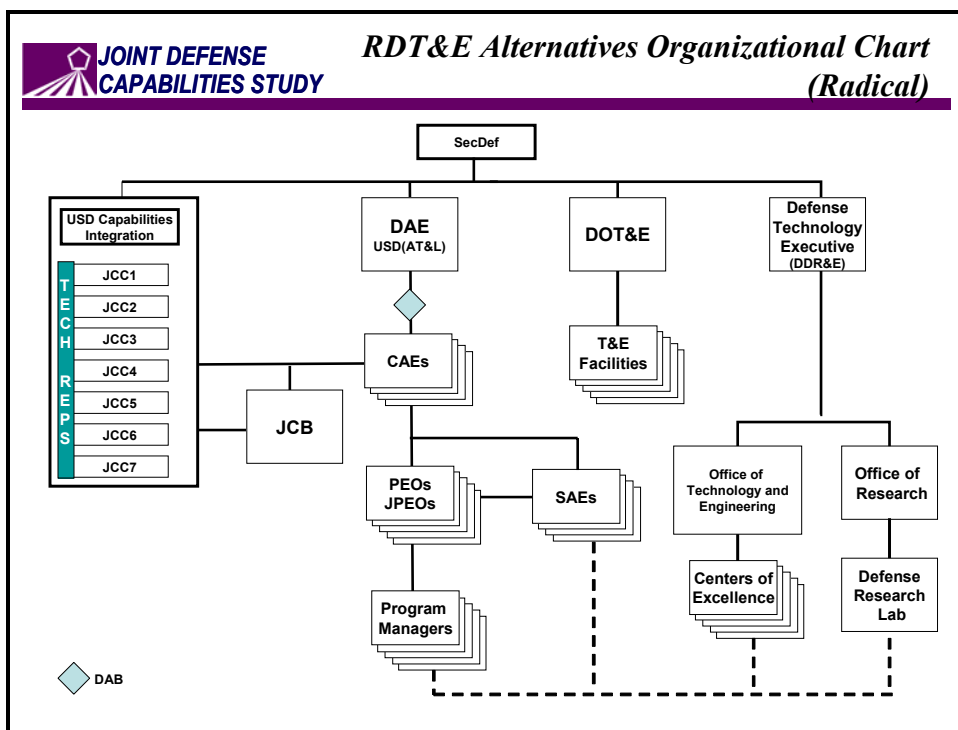

Alt 1 – Moderate – Strengthened Defense Logistics Executive

Description: Use the Defense Logistics Executive (DLE) as the single Logistics, Global Supply Chain Manager with oversight and decision authority for Defense material and maintenance, with visibility of movement.

- Combine logistics related responsibilities (material management, repair, overhaul and transportation) under the DLE with authority to set policy, control joint funds and support the warfighter and readiness. Position to be part of a USD level (already existing as AT&L) and supported by a Joint Logistics Board. This individual would:
 - Determine the DoD Logistics Total Obligation Authority (TOA) for joint logistics programs and acquisitions (TOA amount and % for Joint TBD) as identified by the capabilities process.
 - Establish a Joint Office, for in theater management in support of military operations.
 - Manage the organization which accomplishes Joint Log Programs, e.g., DLA.
 - Oversees sustainment plans organized by joint capability missions, not by Service or Agency.
 - Responsible for integration sustainment planning and execution across the Department, focused on warfighting support and readiness.
 - Plan for efficiencies in operations, e.g., eliminate excess capacity in organic repair facilities.
 - Engage and direct strategic, operational and enhanced capabilities planning, presenting logistics/ supply chain considerations and develops Strategic Log Plan with performance parameters (see Radical alternative for details).
 - Leverage best practices and processes from within DoD, coalition partners and industry to improve efficiency and quality with the global supply chain.
- Pros:**
 - Improves oversight of logistics supply chain by elevating work to a USD level manager.
 - Enhances joint warfighter support by ensuring comprehensive department wide policies and direction.
 - Strengthens support operations in execution phase by having upfront, comprehensive planning.
 - Eliminates excess capacities and duplications.
 - Separate POM for Joint Logistics.
- Cons:**
 - Lines of authority and majority of resources remain fragmented through Services, joint staff, TRANSCOM and DLA.
 - True savings not realized unless infrastructure is taken into account.

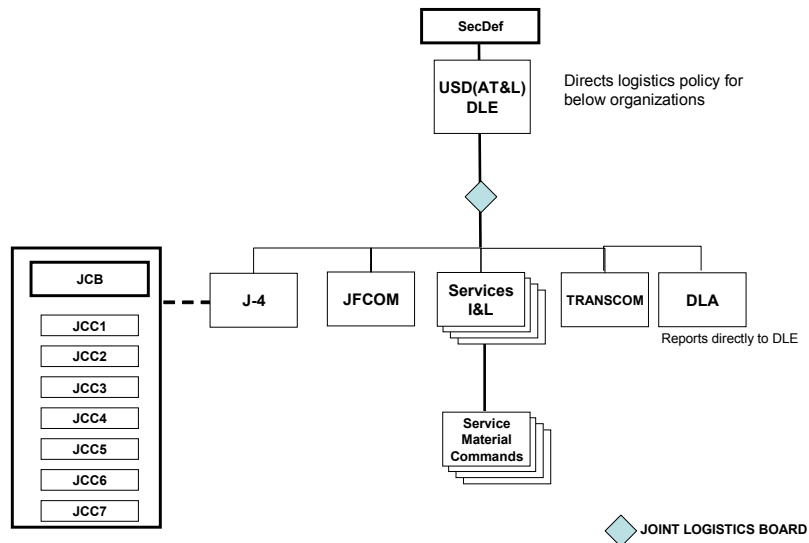



**JOINT DEFENSE
CAPABILITIES STUDY**

Enterprise Planning - Logistics

Alt 2 – Aggressive – Centralize Logistics/Joint Command

Description: Establish a single Logistics, Global Supply Chain Organization (Joint Command/Agency) with oversight and decision authority for all Defense material, maintenance, movement and transportation.

- Combine all logistics related activity (material management, repair, overhaul and transportation) into a single Command with authority to set policy, issue and distribute material, for warfighter support and readiness. The entity, either Command or an Agency, to report at the USD level with J-4 (3 star) as deputy who is dual reporting. This Command/Agency will:
 - Consolidate all funding for joint and single service materials and logistics support by creating an appropriation authority. Execution authority is performed by newly established entities previously part of Services and Defense Agencies.
 - Own all materiel available across DoD with total asset visibility and accessibility.
 - Create department wide policies and procedures for common logistics practices and procedures, to include financial investments.
 - Combine organic repair capabilities, which drives potential inputs to the current BRAC process.
 - Incorporate all duties & responsibilities of the proposed Defense Logistics Executive (DLE) such as develops Strategic Log Plan with performance parameters (see Radical alternative for details).

Pros:

- Enhances joint warfighter support and readiness by ensuring comprehensive department wide policies and direction.
- Makes logistics and supply chain full partners in the planning phases for strategy, operations and capabilities.
- Gains greater efficiencies in organic repair capabilities through involvement with BRAC.

Cons:

- Splits the Services (as users) from critical logistics support.
- Creates large organization under the USD which may be difficult to establish.
- Possible Title X issues – Services' responsibilities.
- Establishment of either Agency or Command has separate implications and needs to be examined which is proper.

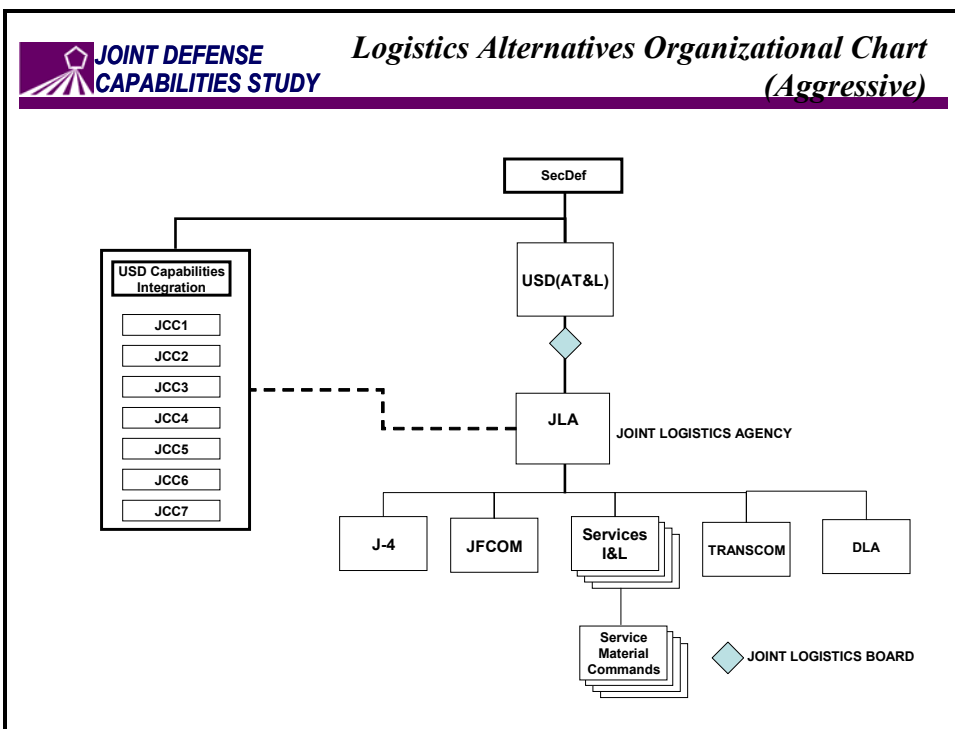

Alt 3 – Radical – Corporate Logistics

Description: Under the OSD-led Command/Agency, pursue alternative governance structures for the various activities to support department logistics requirements; retaining 'core' or critical operations. Best alternative governance structure selection and oversight reside within OSD. Appoint to a term position, with financial performance incentives.

- Most logistics ownership removed from Services and other DoD agencies, and is placed in an entity (Command structure most likely) that reports to OSD. OSD selects the appropriate governance structure to support the requirement. Division of logistics services would be established along functional lines (e.g. combat logistics, operational support, etc.) with limited selected items as needed remaining in DoD. Run on a commercial type basis with a term appointment (e.g., 6 year)
- Alternative governance structures include PBOs, cooperative partnerships, federal government corporations, government-owned contractor operated (GOCO), public-private partnership or joint venture, and ESOPs.
- OSD develops and publishes a Strategic Logistics Plan and coordinates execution with subordinate Command, entity or entities.
 - Articulates goals and roadmap to meet them in published performance plans.
 - Drives input to the Operational plans development.
 - Holistic view of departmental logistics requirements and how they support DoD needs.
 - Consistent with guidance stipulated in the Strategic Planning Guidance (SPG).
 - Integrates "best business practices" into the logistics planning and execution processes.

Pros:

- Insulated from Component agendas.
- Maximizes return on logistics investments.
- Alternative governance structures provide increased flexibility in personnel and acquisition matters.

Cons:

- Variations of risk associated with each governance structure, e.g., profit motive of certain governance structures might conflict with DoD needs.
- Requires new organizational structures; potential to fragment support from a multitude of service providers.
- Congressional approval required for several of the alternative governance structures.
- A step removed from the integrated supply chain concept as it disperses logistics functions.

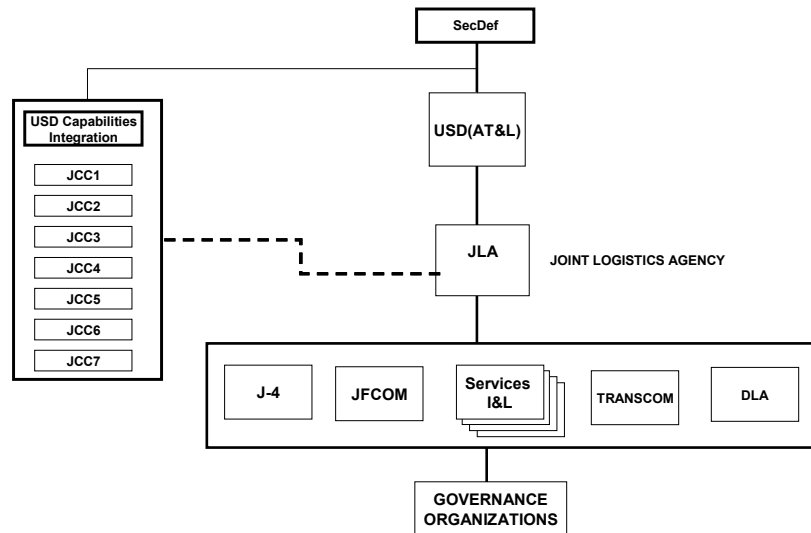



**JOINT DEFENSE
CAPABILITIES STUDY**

Enterprise Planning - Infrastructure

Alt 1 – Moderate – Joint Facilities Directorate

Description: Modify current OSD staff to better participate in the Department's capabilities analysis and integration processes. OSD staff to be realigned/augmented with Service, CoCOM and other DoD agency headquarter staff members to provide a deeper analytic capability. This staff becomes the focal point within the Department on how infrastructure issues meet joint capabilities.

- Directorate resides within AT&L and is staffed with representatives from the Services, CoCOMs and other DoD agencies. Components maintain management responsibilities for assigned infrastructure.
- Directorate heads a Joint Facilities Planning Board that leads the effort to define needs across the Department and oversees and coordinates execution activities. Special emphasis will be placed on those facilities that most directly support the joint warfighter such as depots, training ranges and facilities, joint use bases, and CoCom facilities.
- The staff develops and publishes a biennial Strategic Infrastructure Plan (building on the work done in the Defense Facilities Strategic Plan).
 - Holistic view of departmental assets and how they support joint needs.
 - Consistent with guidance stipulated in the Strategic Planning Guidance (SPG).
 - Integrates "best business practices" into the planning and execution processes.
- The staff develops and publishes appropriate directives to manage joint infrastructure requirements.
- Links to other Enterprise functions (such as logistics) for planning.
- Linked to the Capability Board responsible for Infrastructure.

Pros:

- Cost reductions through better utilization of resources.
 - Focused oversight allows identification of excesses.
 - Joint approach maximizes assets.
- Centralized integrated planning for all infrastructure requirements.

Cons:

- Requires realignment of current organization(s).
- Staffing requirements.
- Limited ability to change current operations.



**JOINT DEFENSE
CAPABILITIES STUDY**

Enterprise Planning - Infrastructure

Alt 2a – Aggressive – ASD Installations & Environment (Joint)

Description: Create an ASD (Installations & Environment), within AT&L, that would resource and direct selected joint infrastructure functions across the Department.

- ASD staff has facilities planning and oversight functions for the Department and resourcing and directive responsibilities for those facilities and activities that most directly support the joint warfighter. Execution authority stays with the designated/appropriate Service or agency.
- Provides directed guidance on joint infrastructure needs, and delegated guidance to Services and other agencies on management of assigned infrastructure.
- Maintains and directs percentage of infrastructure budget to support joint infrastructure capabilities, with financial reporting to track execution and performance.
- ASD develops and publishes a biennial Strategic Infrastructure Plan (building on the work done in the Defense Facilities Strategic Plan), with particular linkage to logistics requirements.
 - Holistic view of departmental assets and how they support joint needs.
 - Consistent with guidance stipulated in the Strategic Planning Guidance (SPG).
 - Integrates "best business practices" into the planning process.

Pros:

- Supports the capabilities-based focus of the Department (vice Component-based focus).
- Cost reductions through better utilization of resources.
 - Focused oversight allows identification of excesses.
 - Joint approach maximizes joint assets.
- Centralized resourcing, direction and integrated planning for all joint infrastructure requirements.

Cons:

- Realignment of existing OSD organization.
- Possible legislative issues.

Alt 2b – Aggressive – ASD Installations & Environment (DoD Wide)

Description: Create an ASD (Installations & Environment), within AT&L, that would resource and direct DoD Wide infrastructure functions across the Department.

- ASD staff has facilities planning and oversight functions for the Department and resourcing and directive responsibilities for facilities and activities. Execution authority stays with the designated/appropriate Service or agency.
- Provides directed guidance on specific infrastructure needs, and delegates remainder to Services and other agencies on management of assigned infrastructure.
- Maintains and directs infrastructure budget to support capabilities, with financial reporting to track execution and performance.
- ASD develops and publishes a biennial Strategic Infrastructure Plan (building on the work done in the Defense Facilities Strategic Plan), with particular linkage to logistics requirements.
 - Holistic view and enforcement of departmental assets and how they support capability needs.
 - Consistent with guidance stipulated in the Strategic Planning Guidance (SPG).
 - Integrates "best business practices" into the planning process.

Pros:

- Supports the capabilities-based focus of the Department (vice Component-based focus).
- Cost reductions through better utilization of resources.
 - Focused oversight allows identification of excesses.
 - DoD wide approach maximizes assets.
- Centralized direction and integrated planning for all infrastructure requirements.

Cons:

- Realignment of existing OSD organization.
- Possible legislative issues.

Alt 3 – Radical – DoD Corporate Infrastructure

Description: Merge all DoD infrastructure functions under one OSD-led entity. OSD would then pursue alternative governance structures for the various activities as appropriate. Alternative governance structure selection and oversight reside within OSD.

- Infrastructure ownership removed from Services and other DoD agencies, and is placed in an entity that reports to OSD. OSD selects the appropriate governance structure to support the requirement. Division of infrastructure services would be established along functional and/or regional lines (e.g. housing, hospitals, airfields, ports, etc.)
 - Alternative governance structures include PBOs, cooperative partnerships, federal government corporations, government-owned contractor operated (GOCO), public-private partnership or joint venture, and ESOPs.
- OSD develops and publishes a Strategic Infrastructure Plan and coordinates execution with subordinate entity or entities.
 - Articulates goals and roadmap to meet them.
 - Holistic view of departmental assets and how they support DoD needs.
 - Consistent with guidance stipulated in the Strategic Planning Guidance (SPG).
 - Integrates "best business practices" into the planning and execution processes.

Pros:

- Insulated from Component agendas.
- Maximizes return on facilities investments.
- Alternative governance structures provide increased flexibility in personnel and acquisition matters.

Cons:

- Profit motive of certain governance structures might conflict with DoD needs.
- Requires new organizational structures; potential to fragment support from a multitude of service providers.
- Congressional approval required.



Workforce Planning Process

Alt 1 - Moderate – More Strategic Approach

Description: Strengthens strategic workforce planning. Strengthens links between joint warfighting and unit training in the Services.

- USD(P&R) and J-7 are mandated to actively participate on all Functional Capability Boards and cross-cutting study groups when alternative solutions have major implications on workforce costs, numbers, training, or skills.
- For strategic planning purposes, USD(P&R) collects and integrates Service projections concerning future numbers, competencies, and skill requirements for military personnel, for civilians, and for contractors used as staff extension.
- All human resources planning would take into account rebalanced active/reserve roles in future operations.
- Tasks trained in single-Service unit training exercises are linked directly to the Universal Joint Task List maintained by Joint Staff.
- JFCOM has increased content control over joint training curricula in Service training and education courses.

Pros:

- Enhances integration of operations and enterprise planning.
- Expands strategic planning to all parts of the workforce.
- Improves links between Service training events and joint warfighting tasks.

Cons:

- Increases workload due to more analysis of workforce implications of capabilities decisions.



Workforce Planning Process

Alt 2 – Aggressive – Integrated Workforce Planning; Improved Joint Content In Training

Description: Integrates workforce planning across different types of personnel. Strengthens links between joint warfighting and schoolhouse and unit training in the Services.

- USD(P&R) and J-7 are mandated to actively participate within Functional Capability Boards and cross-cutting study groups to ensure that all alternative solutions presented to decision-makers on capability issues accurately and fully capture workforce implications -- costs, strength, skill requirements, etc.
- Based on input from the Components, OSD(P&R) produces a single integrated strategic workforce roadmap for combined requirements for military, civilian and contractor personnel used as staff extension.
- All human resources planning would take into account rebalanced active/reserve roles in future operations.
- Training curricula at all organizational levels in the Services (including individual training) directly support the Universal Joint Task List maintained by Joint Staff.
- JFCOM certifies Service training, both individual and collective, as having appropriate joint context.
- Personnel databases document joint training courses taken by civilians as well as military.

Pros:

- Expands strategic planning to all parts of the workforce.
- Strengthens joint training.
- Improves visibility of individuals with joint skills/education.

Cons:

- Requires more complex workforce and training management.

Alt 3 – Radical – JFCOM Manages All Joint Training and Education

Description: Integrates workforce planning across different types of personnel. Fully integrates Service training curricula and the Joint National Training Capability.

- USD(P&R) and J-7 are mandated to actively participate within Functional Capability Boards and cross-cutting study groups to ensure that all alternative solutions presented to decision-makers on capability issues accurately and fully capture workforce implications – costs, strength, skill requirements, etc.
- Based on input from the Components, OSD(P&R) produces a single integrated strategic workforce roadmap for combined requirements for military, civilian and contractor personnel
- All human resources planning would take into account rebalanced active/reserve roles in future operations.
- Joint National Training Capability (JNTC) expands to include all schoolhouse training and Professional Military Education for joint specialties/missions/strategy.
- JNTC Management Office in JFCOM has fiscal control of all joint exercises, joint courses (including schoolhouse and distance learning), and joint and coalition schools.

Pros:

- Fully integrates workforce and training into joint capabilities planning and execution.

Cons:

- Greatly increases workload and requires new competencies in the JNTC Management Office
- Will encounter significant opposition from the Services.

