

**IN THE UNITED STATES DISTRICT COURT
FOR THE NORTHERN DISTRICT OF NEW YORK**

CAR-FRESHNER CORPORATION

and

JULIUS SÄMANN LTD.,

Plaintiffs,

v.

SUN CEDAR, INC.,

Defendant.

Civil Action No. 7:15-CV-1463 [TJM/TWD]

Hon. Judge Therese Wiley Dancks

JURY DEMANDED

DEFENDANT’S ANSWER AND COUNTERCLAIMS

Defendant Sun Cedar, Inc. (hereinafter “Defendant” or “Sun Cedar”), by and through its undersigned counsel, as and for its Answer to Plaintiffs Car-Freshner Corporation and Julius Sämaan Ltd.’s (hereinafter “Plaintiffs” or “Car-Freshner”) Complaint, responds and states as follows:

PRELIMINARY STATEMENT

Plaintiffs’ claims that not-for-profit Sun Cedar’s cedar tree shaped ornaments infringe Plaintiffs’ so-called “Tree Design”¹ marks fail for several reasons. Sun Cedar’s social mission of training and employing the at-risk population, including the homeless, substance-abusers and former felons, is its essential promotional message:

¹ This term is used as Plaintiffs use it in their Complaint.



Sun Cedar uses an iconic cedar tree outline to describe the cedar wood and the cedar scent of its ornaments. The only point of similarity between Sun Cedar’s cedar tree outline and Plaintiffs’ pine tree and block base outline is the unprotectable outline of tree branches.

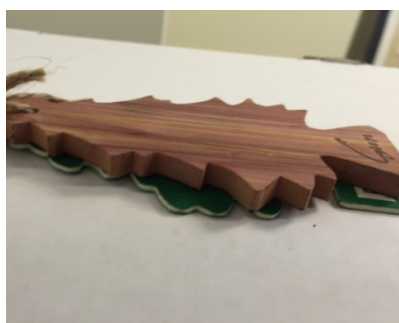

Sun Cedar does not use any distinctive element that Plaintiffs could arguably claim as a mark (such as the saturated green field or block base in its Tree Design). It is questionable whether Plaintiffs can assert rights in either a blank silhouette of a tree or a blank configuration of a pine tree, because Plaintiffs (1) chose the pine tree outline for functional reasons (to the point of

patenting the shape); and (2) have abandoned the blank silhouette registrations, as they do not use blank silhouettes as trademarks in commerce. Finally, Sun Cedar's \$10, thick, wooden ornaments are sold on its website, through Kickstarter, and in "green" retail stores, as opposed to in the gas stations and car washes that sell Plaintiffs' approximately \$1.00 cardboard-thin cellulose car fresheners. The two products never have and never will be offered for sale side by side in any retail setting.



Taking into account Plaintiffs' distinctive yellow and red header card, the price differential, differing channels of trade, and the very different manner of emphasis in the promotional "look," it is virtually impossible that customers of either brand would confuse the two products.

Defendant Sun Cedar, Inc.

Sun Cedar is a not-for-profit based in Lawrence, Kansas, founded by Shine Adams in 2014 to provide employment for the "at-risk" population he encountered, and social services at

the Lawrence Community Shelter.

Mr. Adams, a trained carpenter, built guitars as a sideline and had access to cedar wood scraps. He developed, assisted by several clients of the shelter, a variety of designs carved out of cedar wood. He eventually settled on a cedar tree design because it described the cedar wood, referred to the name of the company, and because, in comparison to many of the other designs, could be cut out of wood by an untrained employee using a scroll saw (no two ornaments are the same).



Sun Cedar’s tree, shown on top of Plaintiffs’ product, is pictured above between sets of “cedar tree” icons available as free Clip Art to illustrate the archetypal rendering of cedar trees. The trunk of Sun Cedar’s tree is realistic and does not share Plaintiffs’ rectangular block base. The “Sun” signature appears on all tree ornaments.

Sun Cedar began offering cedar wood ornaments in October 2014. Many of its tree ornaments were provided as “prizes” for donations. It added cedar coat hangers, potpourris and shoe boxes in June 2015, promoting cedar wood’s moth-proofing properties.



Sun Cedar's mission to train and employ is the pervasive theme of its promotional activity. Photos from its website and social media depict its employees creating its products:



Sun Cedar's trees are promoted as Christmas tree ornaments and artistic ornaments. The trees are often used as decorative bases on which further ornamental designs are added:



When Plaintiffs protested Sun Cedar's sale of its ornaments, Sun Cedar attempted to accommodate Plaintiffs by deleting any reference to cars in promotional materials and foregoing any future sales in the automotive channel used by Plaintiffs. When Plaintiffs protested Sun Cedar's use of representations of its designs in social media profile pictures, Sun Cedar removed such usages.

Consumers of air fresheners are accustomed to seeing shapes used to describe specific scents. For example, pictured below is a display of air fresheners in the shape of cherries, strawberry, hibiscus, tropical flowers and “fresh blooms.”



Additionally, despite Plaintiffs' claims of exclusivity to depictions of trees in the scented product field, the consuming public is regularly exposed to depictions of tree shapes to describe tree-scented products:

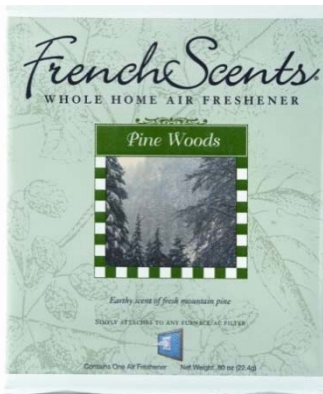



It is fair to say that apart from scented products, consumers are inured to encountering tree-shapes to signify products made of wood.

Unable to allege any actual confusion or facts that suggest confusion, Plaintiffs rely on baseless accusations that Sun Cedar attempts to deceive the consumer into believing that Sun Cedar's products originate from or are endorsed by Plaintiffs.

ANSWER

1. Defendant admits the allegations contained in Paragraph 1 of the Complaint to the extent that this is a lawsuit for alleged trademark infringement, false designation of origin, trademark dilution, and unfair competition. Plaintiffs seek relief under the Lanham Act, 15

U.S.C. § 1051 *et seq.*, New York General Business Law, and New York State common law. Defendant denies the allegations to the extent they imply or suggest any liability.

2. Defendant lacks knowledge or information sufficient to form a belief as to the truth of the allegations contained in the first sentence of Paragraph 2 of the Complaint, and therefore denies the same. Defendant denies the allegations contained in the second sentence of Paragraph 2 of the Complaint. It specifically denies that it has adopted any tree design as a trademark. Defendant denies the allegations contained in the third sentence of Paragraph 2 of the Complaint. Defendant lacks knowledge or information sufficient to form a belief as to the truth of the allegations contained in the fourth sentence of Paragraph 2 of the Complaint, and therefore denies the same. Defendant denies all remaining allegations.

PARTIES

3. Defendant lacks knowledge or information sufficient to form a belief as to the truth of the allegations contained in Paragraph 3 of the Complaint, and therefore denies the same.

4. Defendant lacks knowledge or information sufficient to form a belief as to the truth of the allegations contained in Paragraph 4 of the Complaint, and therefore denies the same.

5. Defendant admits the allegations contained in Paragraph 5 of the Complaint.

JURISDICTION AND VENUE

6. Paragraph 6 of the Complaint contains legal conclusions to which no response is required, but to the extent a response is required, Defendant admits that this Court has subject matter jurisdiction.

7. Paragraph 7 of the Complaint contains legal conclusions to which no response is required, but to the extent a response is required, Defendant denies that venue is proper in this district.

PLAINTIFFS' BUSINESS AND TRADEMARKS

8. Defendant lacks knowledge or information sufficient to form a belief as to the truth of the allegations contained in Paragraph 8 of the Complaint, and therefore denies the same.

9. Defendant lacks knowledge or information sufficient to form a belief as to the truth of the allegations contained in Paragraph 9 of the Complaint, and therefore denies the same.

10. Defendant lacks knowledge or information sufficient to form a belief as to the truth of the allegations contained in Paragraph 10 of the Complaint, and therefore denies the same.

11. Defendant lacks knowledge or information sufficient to form a belief as to the truth of the allegations contained in Paragraph 11 of the Complaint, and therefore denies the same.

12. Defendant lacks knowledge or information sufficient to form a belief as to the truth of the allegations contained in Paragraph 12 of the Complaint, and therefore denies the same.

13. Defendant lacks knowledge or information sufficient to form a belief as to the truth of the allegations contained in Paragraph 13 of the Complaint, and therefore denies the same.

14. Defendant lacks knowledge or information sufficient to form a belief as to the truth of the allegations contained in Paragraph 14 of the Complaint, and therefore denies the same.

15. Defendant lacks knowledge or information sufficient to form a belief as to the truth of the allegations contained in Paragraph 15 of the Complaint, and therefore denies the same.

16. Defendant lacks knowledge or information sufficient to form a belief as to the truth of the allegations contained in Paragraph 16 of the Complaint, and therefore denies the same.

17. Defendant lacks knowledge or information sufficient to form a belief as to the truth of the allegations contained in Paragraph 17 of the Complaint, and therefore denies the same.

18. Defendant lacks knowledge or information sufficient to form a belief as to the truth of the allegations contained in Paragraph 18 of the Complaint, and therefore denies the same.

19. Defendant denies that it has committed any infringing or diluting acts. Defendant lacks knowledge or information sufficient to form a belief as to the truth of the remaining allegations contained in Paragraph 19 of the Complaint, and therefore denies the same.

20. Defendant denies the allegations contained in Paragraph 20 of the Complaint.

21. Defendant admits that Julius Sämaan Ltd. is the record owner of the registrations contained in Paragraph 21 of the Complaint. Defendant denies the remaining allegations contained in Paragraph 21 of the Complaint, and notes that the Tree Design registrations are not enforceable for the reasons discussed below.

22. Defendant denies that the registration numbers contained in Paragraph 22 of the Complaint are incontestable, because registrations are always vulnerable to attack on grounds of functionality and abandonment, as is the case here.

23. Paragraph 23 of the Complaint contains legal conclusions to which no response is required.

24. Defendant denies the allegations contained in Paragraph 24 of the Complaint.

25. Defendant denies the allegations contained in Paragraph 25 of the Complaint.

DEFENDANT’S ACTIVITIES

26. Defendant admits that it manufactures, markets, promotes, advertises, distributes and sells cedar tree ornaments, such as the ones depicted in Paragraph 26 of the Complaint.

Defendant denies the remaining allegations contained in Paragraph 26 of the Complaint.

27. Defendant denies that its cedar tree ornaments are “[i]nfringing.” Defendant admits the remaining allegations in Paragraph 27 of the Complaint.

28. Defendant denies that its cedar tree ornaments are “[i]nfringing.” Defendant admits that its cedar tree ornaments have been referred to as “air fresheners” and “hanging tree air fresheners,” and denies the remaining allegations contained in Paragraph 28 of the Complaint.

29. Defendant admits that it sells t-shirts, such as the one depicted in Paragraph 29 of the Complaint. Most t-shirts have been distributed as “prizes” for donations. Defendant denies the remaining allegations contained in Paragraph 29 of the Complaint.

30. Defendant denies the allegations contained in Paragraph 30 of the Complaint.

31. Defendant admits that it promotes its cedar tree ornaments and other products via its website and through social media. Defendant denies the remaining allegations contained in Paragraph 31 of the Complaint.

32. Defendant admits that the images contained in Paragraph 32 of the Complaint depict previous versions of its social media profiles, but denies that the images are an accurate representation of its current social media profiles. Defendant denies the remaining allegations contained in Paragraph 32 of the Complaint.

33. Defendant admits that the illustration is an accurate depiction of a prior version of Defendant's home page. Defendant denies the remaining allegations contained in Paragraph 33 of the Complaint.

34. Defendant denies the allegations in Paragraph 34 of the Complaint to the extent that the photograph referred to has been cropped by Plaintiffs so as to remove Mr. Adams from the photograph.

35. Defendant denies the allegations contained in Paragraph 35 of the Complaint.

36. Defendant admits that the image contained in Paragraph 36 of the Complaint reflects a portion of its social media profile as it existed at the time of the Complaint. Defendant denies the remaining allegations in Paragraph 36 of the Complaint.

37. Defendant denies the allegations contained in Paragraph 37 of the Complaint.

38. Defendant admits that it has, in the past, posted images of its cedar tree ornaments hanging in a vehicle. Defendant denies the remaining allegations contained in Paragraph 38 of the Complaint and notes that it no longer displays images of vehicles at this time nor does it promote automotive usages of its product.

39. Defendant denies the allegations contained in Paragraph 39 of the Complaint as Plaintiffs have not accurately reproduced the referred to literature.

40. Defendant denies that its cedar tree ornaments or other products are "[i]nfringing." Defendant admits the remaining allegations contained in Paragraph 40 of the Complaint.

41. Defendant denies the allegations contained in Paragraph 41 of the Complaint.

42. Defendant denies the allegations contained in Paragraph 42 of the Complaint.

43. Defendant denies the allegations contained in Paragraph 43 of the Complaint.

44. Defendant denies the allegations contained in Paragraph 44 of the Complaint.

45. Defendant denies the allegations contained in Paragraph 45 of the Complaint.

46. Defendant denies the allegations contained in Paragraph 46 of the Complaint.

47. Defendant denies the allegations contained in Paragraph 47 of the Complaint.

48. Defendant denies the allegations contained in Paragraph 48 of the Complaint, but admits that Plaintiffs have had prior correspondence with Defendant asserting Plaintiffs' alleged rights. Defendant denies the remaining allegations contained in Paragraph 48 of the Complaint. It emphatically denies the allegation that it willfully disregarded Plaintiffs' rights as Sun Cedar retained counsel specifically to respond to Plaintiffs' asserted claims.

49. Defendant denies that its cedar tree ornaments or other products are "[i]nfringing." Defendant admits the remaining allegations contained in Paragraph 49 of the Complaint.

50. Defendant admits that it offers its products in the state of New York. Defendant denies the remaining allegations contained in Paragraph 50 of the Complaint.

51. Defendant denies that its cedar tree ornaments or other products are "[i]nfringing." Defendant admits the remaining allegations contained in Paragraph 51 of the Complaint.

52. Defendant denies the allegations contained in Paragraph 52 of the Complaint.

COUNT I
INFRINGEMENT OF A REGISTERED TRADEMARK (FEDERAL)

53. Defendant repeats and incorporates herein by reference each and every response contained in Paragraphs 1 through 52, as though fully set forth herein.

54. Defendant denies the allegations contained in Paragraph 54 of the Complaint.

55. Defendant denies the allegations contained in Paragraph 55 of the Complaint.

56. Defendant denies the allegations contained in Paragraph 56 of the Complaint.

57. Defendant denies the allegations contained in Paragraph 57 of the Complaint.

COUNT II
TRADEMARK INFRINGEMENT AND UNFAIR COMPETITION (FEDERAL)

58. Defendant repeats and incorporates herein by reference each and every response contained in Paragraphs 1 through 57, as though fully set forth herein.

59. Defendant denies the allegations contained in Paragraph 59 of the Complaint.

60. Defendant denies the allegations contained in Paragraph 60 of the Complaint.

61. Defendant denies the allegations contained in Paragraph 61 of the Complaint.

62. Defendant denies the allegations contained in Paragraph 62 of the Complaint.

COUNT III
TRADEMARK DILUTION (FEDERAL)

63. Defendant repeats and incorporates herein by reference each and every response contained in Paragraphs 1 through 62, as though fully set forth herein.

64. Defendant lacks knowledge or information sufficient to form a belief as to the truth of the allegations contained in the first sentence of Paragraph 64 of the Complaint, and therefore denies the same.

65. Defendant denies the allegations contained in Paragraph 65 of the Complaint.

66. Defendant denies the allegations contained in Paragraph 66 of the Complaint.

67. Defendant denies the allegations contained in Paragraph 67 of the Complaint.

68. Defendant denies the allegations contained in Paragraph 68 of the Complaint.

COUNT IV
NEW YORK STATE DILUTION

69. Defendant repeats and incorporates herein by reference each and every response contained in Paragraphs 1 through 68, as though fully set forth herein.

70. Defendant lacks knowledge or information sufficient to form a belief as to the truth of the allegations contained in the first sentence of Paragraph 70 of the Complaint, and therefore denies the same.

71. Defendant denies the allegations contained in Paragraph 71 of the Complaint.

72. Defendant denies the allegations contained in Paragraph 72 of the Complaint.

73. Defendant denies the allegations contained in Paragraph 73 of the Complaint.

COUNT V
UNFAIR COMPETITION (COMMON LAW)

74. Defendant repeats and incorporates herein by reference each and every response contained in Paragraphs 1 through 73, as though fully set forth herein.

75. Defendant denies the allegations contained in Paragraph 75 of the Complaint.

76. Defendant denies the allegations contained in Paragraph 76 of the Complaint.

77. Defendant denies the allegations contained in Paragraph 77 of the Complaint.

ANSWER TO PRAYER FOR RELIEF

Defendant denies that Plaintiffs are entitled to the judgment and relief prayed for in their Prayer for Relief.

GENERAL DENIAL

Defendant denies each and every factual allegation in the Complaint that is not specifically admitted or otherwise addressed in the preceding Paragraphs and demands strict proof thereof.

AFFIRMATIVE DEFENSES

As and for its Affirmative Defenses, Defendant hereby alleges as follows:

First Affirmative Defense

Plaintiffs' claims, in whole or in part, fail to state a claim for which relief may be granted.

Second Affirmative Defense

Plaintiffs' requested relief is barred, in whole or in part, by fair use.

Third Affirmative Defense

Plaintiffs' requested relief is barred, in whole or in part, by the First Amendment.

Fourth Affirmative Defense

Plaintiffs' claims, in whole or in part, are barred by the doctrines of laches, estoppel, acquiescence, and/or waiver.

Fifth Affirmative Defense

Plaintiffs' claims, in whole or in part, are barred because, on information and belief, Plaintiffs have abandoned their rights in one or more marks through non-use.

Sixth Affirmative Defense

Plaintiffs' claims, in whole or in part, are barred because one or more of Plaintiffs' marks are invalid as aesthetically functional.

Seventh Affirmative Defense

Plaintiffs' claims, in whole or in part, are barred because one or more of Plaintiffs' marks are invalid as functional.

Eighth Affirmative Defense

Defendant Sun Cedar hereby gives notice that it intends to rely on such other and further defenses as may become available or apparent during discovery in this case, and it hereby reserves the right to amend its Answer to assert any such defenses.

COUNTERCLAIM FOR CANCELLATION OF REG. NO. 1,781,016
(Abandonment)

1. Defendant believes that it will be damaged by the continued registration of U.S. Reg. No. 1,781,016 (the “’016 Reg.”) and hereby, as its counterclaim, petitions to cancel the same pursuant to Section 14 of the Lanham Act.

2. Because Plaintiffs base their Complaint in part on the ‘016 Reg., Sun Cedar is being harmed by the continuing registration of the design mark under the ‘016 Reg.

3. The ‘016 Reg. has the following drawing:



4. The ‘016 Reg. describes the mark as “a configuration of the goods with which it is used.”

5. The most recent specimen filed by Plaintiffs includes the following images:



6. Any depiction of any mark in Paragraph 5 above has a different commercial impression from the drawing in the '016 Reg.

7. Upon information and belief, Plaintiffs use no marks that have the same commercial impression as the drawing in the '016 Reg.

8. Plaintiffs have abandoned the mark covered by the '016 Reg.

COUNTERCLAIM FOR CANCELLATION OF REG NO. 1,791,233
(Abandonment)

9. Defendant incorporates by reference the allegations of Paragraphs 1-8.

10. Defendant believes that it will be damaged by the continued registration of U.S. Reg. No. 1,791,233 (the "'233 Reg.>") and hereby, as its counterclaim, petitions to cancel the same pursuant to Section 14 of the Lanham Act.

11. Because Plaintiffs base their Complaint in part on the '233 Reg., Sun Cedar is being harmed by the continuing registration of the design mark under the '233 Reg.

12. The '233 Reg. has the following drawing:



13. The '233 Reg. describes the mark as "a configuration of the good with which it is used."

14. The most recent specimen filed by Plaintiffs includes the following images:

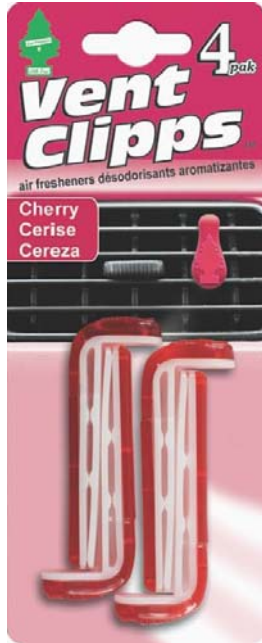

15. Any depiction of any mark in Paragraph 14 above has a different commercial impression from the drawing in the '233 Reg.

16. Upon information and belief, Plaintiffs use no marks that have the same commercial impression as the drawing in the '233 Reg.

17. Plaintiffs have abandoned the mark covered by the '233 Reg.

COUNTERCLAIM FOR CANCELLATION OF REG. NO. 1,726,888
(Abandonment)

18. Defendant incorporates by reference the allegations of Paragraphs 1-17.

19. Defendant believes that it will be damaged by the continued registration of U.S. Reg. No. 1,726,888 (the "'888 Reg.>") and hereby, as its counterclaim, petitions to cancel the same pursuant to Section 14 of the Lanham Act.

20. Because Plaintiffs base their Complaint in part on the '888 Reg., Sun Cedar is being harmed by the continuing registration of the design mark under the '888 Reg.

21. The '888 Reg. has the following drawing:



22. The USPTO TESS and TSDR databases and the registration certificate do not appear to show a description for the mark covered by the '888 Reg.

23. The most recent specimen filed by Plaintiffs includes the following image:

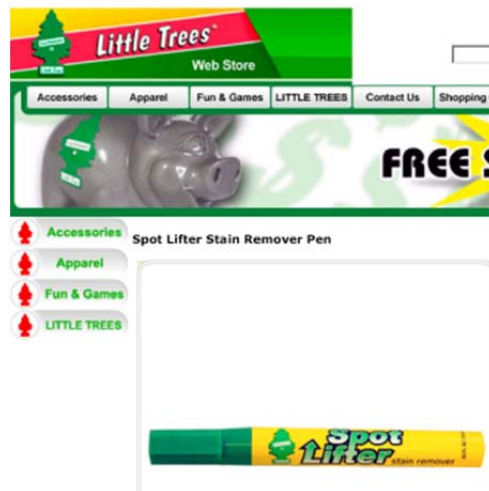

24. Any depiction of any mark in Paragraph 23 above has a different commercial impression from the drawing in the '888 Reg.

25. Upon information and belief, Plaintiffs use no marks that have the same commercial impression as the drawing in the '888 Reg.

26. Plaintiffs have abandoned the mark covered by the '888 Reg.

COUNTERCLAIM FOR CANCELLATION OF REG. NO. 4,592,854
(Abandonment)

27. Defendant incorporates by reference the allegations of Paragraphs 1-26.

28. Defendant believes that it will be damaged by the continued registration of U.S. Reg. No. 4,592,854 (the “‘854 Reg.”) and hereby, as its counterclaim, petitions to cancel the same pursuant to Section 14 of the Lanham Act.

29. Because Plaintiffs base their Complaint in part on the ‘854 Reg., Sun Cedar is being harmed by the continuing registration of the design mark under the ‘854 Reg.

30. The ‘854 Reg. has the following drawing:



31. The ‘854 Reg. describes the mark as the silhouette of a tree design.

32. The most recent specimen filed by Plaintiffs includes the following images:



33. Any depiction of any mark in Paragraph 32 above has a different commercial impression from the drawing in the ‘854 Reg.

34. Upon information and belief, Plaintiffs use no marks that have the same commercial impression as the drawing in the ‘854 Reg.

35. Plaintiffs have abandoned the mark covered by the ‘854 Reg.

CANCELLATION OF REG. NOS. 719,498; 1,781,016; 1,791,233; 1,726,888; 2,741,364; 4,096,100 and 4,592,854 ON THE GROUND OF FUNCTIONALITY

36. Defendant incorporates by reference the allegations of Paragraphs 1-35.

37. The conical shape of Plaintiffs' tree design, the placement of the branches, and rectangular block base all serve functions essential to the use and display of the product, namely: (1) the conical shape and branches allow for gradual dispersal of the fragrance in the freshener product, according to a sequential diagram printed on the back of the package, and (2) the rectangular block base allows for efficient display on Plaintiffs' "strip display," a device used at retail stores to display a variety of scented fresheners in a space-efficient manner.

38. Julius Sämann is the owner of record of the now expired United States Patent No. 3,065,915 (the "'915 Patent," attached as Exhibit A) entitled "Container For Volatile Substances." The subject of the '915 Patent is a system for incrementally removing a tree-shaped air freshener from the packaging over time such that the rate of the scent released is controlled. Specifically, the '915 Patent claims packaging comprising, among other things, the following:

- (1) a flat absorbent body with a point at the top and an outline which flares outward toward the bottom; and
- (2) a system of markings on the body of the air freshener that can align with indicia on the envelope to permit incremental adjustment as the body is progressively moved out of the top of the envelope and exposed to the atmosphere, allowing the scent to be released.

39. Drawings for the '915 Patent include:

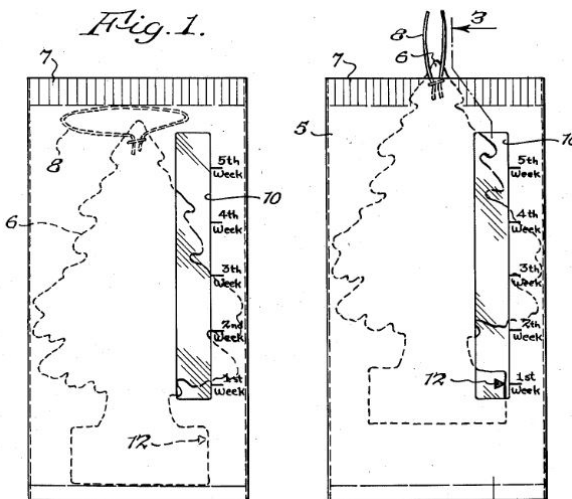

40. The '915 Patent was filed on January 8, 1959, issued on November 27, 1962, and has been expired for over 30 years.

41. Upon information and belief, Plaintiffs' claimed Tree Design marks resemble the drawing and description in the '915 Patent in that both are conical in shape, featuring tree branches with rounded edges, resembling a pine tree, and having a block base.

42. Plaintiffs' product features the following diagram on the back of its packaging:



43. Upon information and belief, this diagram illustrates the system claimed by the '915 Patent. Specifically, the diagram consists of seven images, each showing the body of the air freshener in different stages of removal from the cellophane package over a seven week period. A notch is cut in the center of the cellophane. The first week, the packaging is pulled down to the first branch and only the top of the tree is exposed. The second week, the packaging is pulled down to the second branch, exposing more of the tree, and the cellophane is tucked

under the corresponding branches. This continues until the seventh week, when the tree is removed completely from the packaging.

44. Third party media, such as Cars.com and a certified Toyota dealership, have cited to the diagram and reported successfully utilizing the conical tree shape so as to employ the seven week system, thus proving the functional nature of the tree shape. *See* Exhs. B and C attached hereto.

45. In short, upon information and belief, the shape of the Tree Design is essential to the use or purpose of the article for which it is registered, namely air fresheners. As such, the Tree Design is functional and is not entitled to registration, pursuant to Section 14(3) of the Lanham Act, 15 U.S.C. § 1064(3).

46. The block base of the Tree Design is functional as well. Upon information and belief, Plaintiffs promote their products using a strip display as depicted below:



47. As previously discussed in cases involving Plaintiffs, strip displays allow for “the maximum number of products in an efficient small size.” *Car-Freshner Corp. v. D & J*

Distributing and Mfg., Inc., No. 14-CV-391 PKC, 2015 WL 3385683, at *6 (S.D.N.Y. May 26, 2015) (internal quotations omitted).

48. The block base allows for the efficient display of scent names in a strip display:



49. In summary, upon information and belief, the shape of the Tree Design is essential to uses or purposes of the article for which it is registered, namely air fresheners. As such, the Tree Design is functional and is not entitled to registration, pursuant to Section 14(3) of the Lanham Act, 15 U.S.C. § 1064(3).

DECLARATORY JUDGMENT THAT THERE ARE NO ENFORCEABLE RIGHTS IN PLAINTIFFS' TREE DESIGN

50. Defendant incorporates by reference the allegations of Paragraphs 1-49.

51. Plaintiffs do not have any enforceable right in the Tree Design, by statute or at common law.

52. Plaintiffs' Tree Design is unenforceable for one or more of the following reasons: descriptiveness, functionality, or abandonment.

53. Accordingly, Plaintiffs are not entitled to any rights in the registrations identified in the Complaint or any other rights at common law in the Tree Design.

RELIEF REQUESTED

WHEREFORE, Defendant prays for the following relief:

- A. Dismissal of the Complaint with prejudice;
- B. An award to Defendant of its costs in this action including its reasonable attorneys' fees; and
- C. Such other and further relief as the Court may deem just and proper.

Dated: August 19, 2016
White Plains, NY

Respectfully submitted,



Martin B. Schwimmer
LEASON ELLIS LLP
One Barker Avenue, Fifth Floor
White Plains, New York 10601
Phone: (914) 288-0022
Facsimile: (914) 288-0023
Email: schwimmer@leasonellis.com

Attorney for Defendant

CERTIFICATE OF SERVICE

I hereby certify that a true copy of Defendant's Answer and Counterclaims was served upon the attorney of record for each other party by CM/ECF and first class mail on August 19, 2016 at the below addresses:

Eric J. Shimanoff
Cowan, Liebowitz & Latman, P.C.
114 West 47th Street, 21st Floor
New York, NY 10036-1525
Email: ejs@cll.com

Ashley D. Hayes
Hancock, Estabrook Law Firm
100 Madison Street, Suite 1500
Syracuse, NY 13202
Email: ahayes@hancocklaw.com



Martin B. Schwimmer
LEASON ELLIS LLP
One Barker Avenue, Fifth Floor
White Plains, New York 10601
Phone: (914) 288-0022
Facsimile: (914) 288-0023
Email: schwimmer@leasonellis.com

Attorney for Defendant

EXHIBIT A

Nov. 27, 1962

J. SAMANN

3,065,915

CONTAINER FOR VOLATILE SUBSTANCES

Filed Jan. 8, 1959

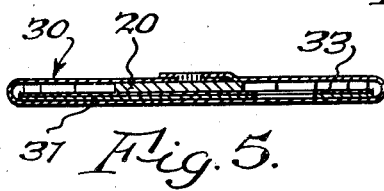
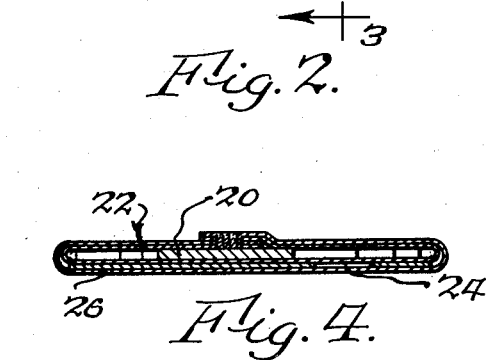
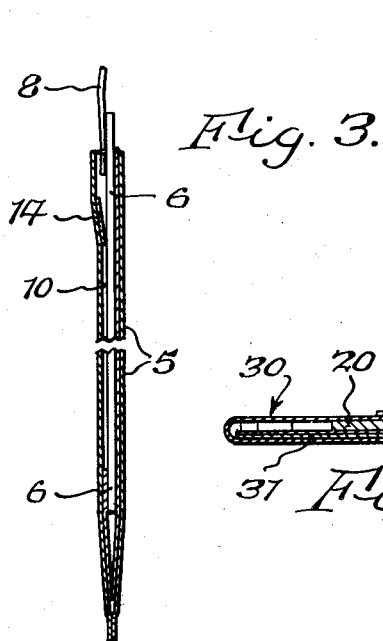
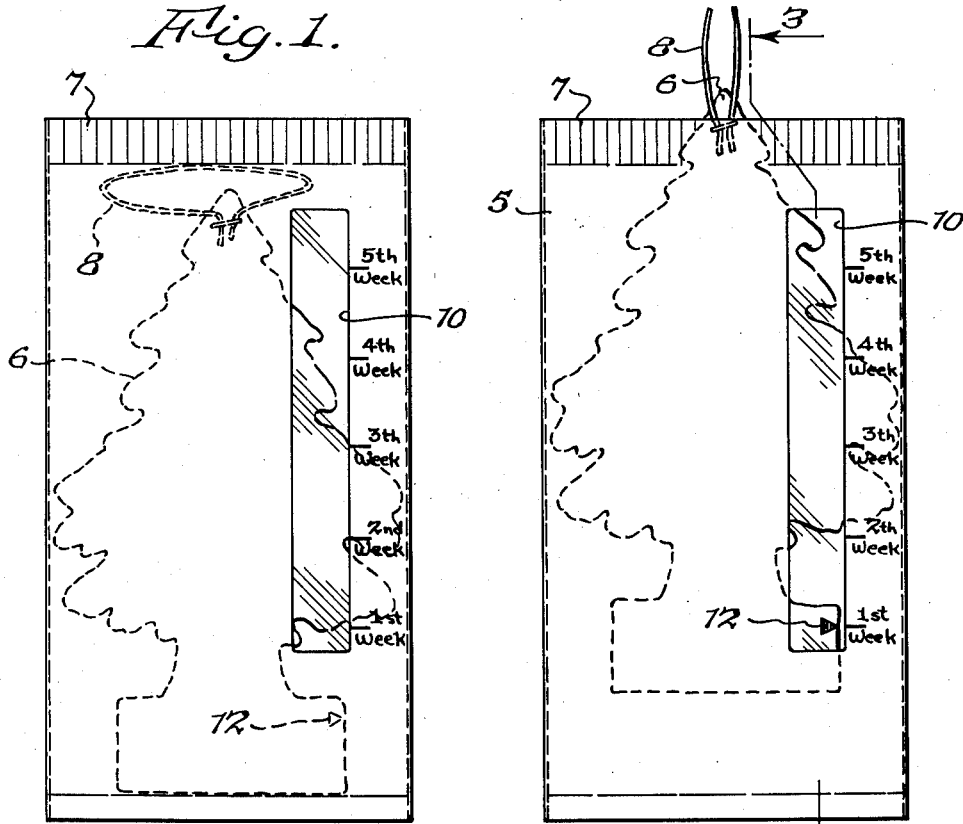

INVENTOR.
Julius Samann
BY *Robert Prochnow*
Attorneys.

United States Patent Office

3,065,915

Patented Nov. 27, 1962

1

3,065,915

CONTAINER FOR VOLATILE SUBSTANCES

Julius Samann, Alpenstrasse 11, Zug, Switzerland

Filed Jan. 8, 1959, Ser. No. 785,724

1 Claim. (Cl. 239—35)

This invention relates to improvements in envelopes or pouches for porous members impregnated with volatile substances by means of which the volatilization of such substances can be retarded or controlled.

Certain substances, such as odor-destroying, air-perfuming, or insect-destroying substances, are generally quite volatile and porous members impregnated with the same have heretofore been enclosed in impervious envelopes or pouches from which such members may be partially withdrawn to avoid excessive volatilization, as shown in my Patent No. 2,757,957 of August 7, 1956. In such articles the extent to which the impregnated members should be withdrawn from the pouches was not indicated, and frequently purchasers of these articles did not realize that the rate of volatilization could be controlled by withdrawing the impregnated member only partially from the pouch, and such purchasers frequently removed the porous members entirely from the pouches with the result that the volatilization was too rapid and produced an excessively heavy and consequently unpleasant odor.

It is therefore one of the objects of this invention to provide an envelope or package for porous, impregnated members of this kind which may be opened at one end to permit withdrawal of said porous member, and which is provided with graduations on the package or envelope positioned to cooperate with an indicator on the porous member so that the user of the device may readily see to what extent the member should be withdrawn from the pouch.

In the accompanying drawings:

FIG. 1 is a face view of a container or pouch embodying this invention and having contained therein a porous member impregnated with a volatile substance;

FIG. 2 is a similar view thereof showing the porous member partly removed from the container;

FIG. 3 is a sectional elevation thereof on line 3—3, FIG. 2;

FIG. 4 is a sectional plan view of a pouch or container of modified construction;

FIG. 5 is a sectional elevation similar to FIG. 3 but showing a pouch of another modified construction.

The envelope or pouch 5 may be of any suitable impervious material in which a porous member or device 6 may be contained. This porous member which may, for example, be made of absorbent material such as employed in blotting or filter paper, and contains or is impregnated with a volatile substance, and when the pouch containing the member is sealed, none or very little of the volatile material will escape from the pouch. The pouch is formed to be opened at one side, for example, in the upper side or end 7 in the construction illustrated, and the porous member is preferably provided with a string or cord 8 by means of which it may be suspended. This member may be partly withdrawn so that the upper portion thereof projects through the top of the container or pouch to any desired extent. The pouch may initially be opened at its upper end only to a slight extent so that only a small portion of the porous member extends out of the pouch. In such cases the volatilization of the substances with which the member is impregnated will take place slowly, mainly from the portion of the member which extends beyond the open end of the pouch.

The front panel or face of the pouch may be provided with printing on either the inner or outer face thereof, or rendered at least partly opaque, but is provided with a

2

clear, transparent portion or window 10 through which a part of the porous and impregnated member 6 is visible, and in order to guide the user to the extent to which the member 6 should be removed from the pouch, graduations are provided on the front face of the pouch adjacent to the window 10. These graduations, for example, may represent intervals of time during which different portions of the member may be exposed to the atmosphere. For example, for the first week a small part of the upper portion of the member can be withdrawn from the pouch, and then for the second week the member is further withdrawn, the graduations in that case being spaced apart to indicate weeks.

Cooperating with these graduations is an indicator on the porous member 6. This indicator may be of any desired type, such for example as a word or the printed matter on the porous member, a part of this member or an arrow 12 shown by way of example in FIG. 1, on the lower portion of the member, in position to be clearly seen through the window 10. When the indicator or arrow 12 is opposite the first graduation marked "1st week," the upper end of the porous member will extend only to a slight extent beyond the upper end of the pouch. These graduations are spaced apart in such a manner as to produce a substantially uniform amount of volatilization of the material with which the porous member is impregnated. For example, during the initial position of the member, only a small portion of the upper end of the same is exposed to the atmosphere. As the porous member 6 gradually loses its strength, relatively larger parts of this member may be exposed to the atmosphere by moving the porous member so that the indicator 12 is opposite the graduation marked "2nd week."

In the particular construction illustrated, the porous member is in the form of a tree and this generally conical shape serves two purposes. In the first place, when the volatile material is of the maximum strength, only a small part of the apex of the tree or conical member is exposed and gradually larger areas of the tree are exposed to the atmosphere while smaller portions of the volatile material are left in the pouch. Another purpose of the conical shape is that as the opening in the upper end 7 of the pouch is gradually increased in size, the conical shape limits the extent to which the member may be drawn out of the pouch and holds the pouch in place on the porous member. When the strength of the volatile material has greatly diminished, the pouch can be entirely removed from the porous member which may then be used without the pouch until it has lost its effectiveness.

The usual printed matter on the pouch may be on the inner surface of the front panel of the pouch, as shown at 14 in FIG. 3, or it may be on the exterior surface of the pouch. The printed matter preferably covers a large enough area of the front panel so that the clear space or window 10, which is free of printing, will be conspicuous and readily noticed by contrast.

In the event that the pouch is printed on the inner face and the volatile substance in the pouch has a detrimental effect on the printing on the inner face of the pouch or on a card, such difficulty can be overcome by providing a pouch or envelope with a double front wall as shown in FIG. 4. In this case the inner pouch 22 is transparent and would serve only to confine the volatile material, and the printed matter would be on the double front wall 26 having a window 24 through which the porous member 20 and the indicator thereon would be visible. In using this construction the porous member 20 would be withdrawn to the extent indicated by the graduations on the outer wall of the double-walled pouch. In this construction the transparent film extends also

3,065,915

3

around the back face of the pouch and is overlapped to form a heat or adhesive seal.

In FIG. 5 I have shown a slightly modified form of my invention in which a pouch 30 is made entirely of transparent material and a layer or card 31 of paper or other material is arranged at the front face of the pouch, this layer or card being provided with a window and having the graduations printed thereon adjacent to the window, so that they could be seen through a transparent part of the pouch. This card is preferably of a size approximately equal to the interior of the pouch so that when the sealed portions of the upper end of the pouch are opened, the remaining unopened portions will keep the card within the pouch while the porous member is withdrawn. A card or paper of this kind may be used in place of printing in the construction shown in FIG. 4, by inserting the card between the inner and outer front panels of the double walled pouch.

The operation of the article shown in FIGS. 4 and 5 is of course identical with that shown in FIGS. 1-3. If the volatile substance is of a nature which would discolor or stain the card by contact, the back face of the card adjacent to the porous member can be covered with a layer of metal foil or the like 33, thus making it possible to insert the paper or card with printed matter thereon into the same pouch or container with the porous member.

By means of the construction described, the porous device and pouch can be readily adjusted relatively to each other so that a substantially uniform amount of volatilization of the material with which the porous member is impregnated will take place, thus making it possible to impregnate the porous member with a relatively large quantity of volatile material so that the article can remain effective for deodorizing and perfuming a room or other enclosure for a much longer period of time than would be the case if the porous member were impregnated with a smaller quantity of the volatile substance. If the extent of withdrawal of the porous device from the pouch were left entirely to the judgment of the user, he might waste much of the volatile substance by excessive withdrawal of the member from the pouch, and the resulting strong odor might be displeasing to him.

It will be understood that various changes in the details, materials and arrangements of parts which have been herein described and illustrated in order to explain

4

the nature of the invention may be made by those skilled in the art within the principle and scope of the invention as expressed in the appended claim.

I claim:

5 A vapor dispensing package for releasing an incremental amount of a volatile substance to the atmosphere, comprising: a flat closed envelope of thin impervious material with a sealed top end adapted to permit progressive opening thereof; a flat absorbent body impregnated with the volatile substance and disposed within said envelope; 10 the envelope having an opaque front face with a clear longitudinally extending window through which the absorbent body may be seen; a marking on said body aligned with the window so that it appears in the window and travels along the length thereof toward the top end of the envelope as the body is progressively moved out of the top of the envelope; indicia on said front face and longitudinally spaced along the length of said window, said 15 indicia permitting incremental adjustment of the area of the absorbent body moved out of the envelope through its top end and exposed to the atmosphere; said absorbent body having a point at the top and an outline which flares outward toward the bottom, the outline and the indicia being correlated so that the desired area of the body is exposed; said body outline being sufficiently rigid to pierce the seal of the top end of the envelope and progressively widen the opening as the body is moved 20 therethrough; the unbroken sealed portion of the envelope and the outline of the absorbent body cooperating to hold the body and the envelope in adjusted relation.

References Cited in the file of this patent

UNITED STATES PATENTS

1,857,367	Ellison -----	May 10, 1932
1,895,236	Smith et al. -----	Jan. 24, 1933
2,069,179	Dunaway -----	Jan. 26, 1937
2,155,057	Moore -----	Apr. 18, 1939
2,593,060	Schrader -----	Apr. 15, 1952
2,757,957	Samann -----	Aug. 7, 1956
2,763,395	Meek -----	Sept. 18, 1956
2,766,067	Shinberg -----	Oct. 9, 1956
2,797,844	Meek -----	July 2, 1957

FOREIGN PATENTS

281,201	Italy -----	Jan. 5, 1931
545,113	Great Britain -----	May 11, 1942

EXHIBIT B



Alexander Hamilton! HEAR LIN-MANUEL MIRANDA TELL IT Free audiobook

Air Supply: Putting Today's Fresheners to the Test

By Courtney Messenbaugh

August 14, 2012



My car has a special stench. It's a stench reserved for those of us in our familial prime, those of us whose cars have been the scene of many scent crimes, from dirty diapers to long-forgotten gym bags to plenty of spilt milk. But there is no need to cry. Since we live in a world obsessed with trying to superficially cover up all problems big and small, the marketplace is full of automotive air fresheners, and they're no longer just simple cardboard pine trees.

When I began this scent-sational (sorry) journalistic mission, I was surprised to discover how crowded the automotive air freshener market actually is. The abundance of choices nearly rivals the abundance of cereal choices these days. Clearly, expert guidance is required. I purchased and thoroughly tested a host of air fresheners so that you can make an informed choice should your car ever start to smell like mine does.

My rating system is like IHHS' in that each product receives a Good, Acceptable, Marginal or Poor rating based on my experience. The prices below may vary depending on where you live and where you buy.

Little Trees Air Freshner

Price: \$1.25 each

Rating: Good

The original. They've been around for 60 years for a reason. They're light, inexpensive, easy to hang, available in over 60 fragrances, and they give off a subtle but effective scent. Surprisingly, Little Trees last quite a while if used correctly. Don't tear open the packaging and hang the Tree; instead, follow the instructions and tear only a small

Start Shopping

Find cars for sale near you

Research a specific model

Compare Vehicles

Here at 3am to find you discounts and help life go right.

Top Stories

01 2016 Toyota 4Runner TRD Pro Photo Gallery

02 2017 Jaguar F-Pace Review: First Drive

03 Alfa Romeo 4C Spider: Pro on the Track, Pain on the Street

04 What's the Best Midsize Sedan for 2016?

Febreze Car Vent Clips

Price: \$5.35

Rating: Good/Acceptable

These clips claim to eliminate car odors rather than just cover them up. Total incineration would not be able to eliminate the odors in my car, but these clips did a decent job. They are small, plastic squares filled with pleasant-smelling liquid, and a dial lets you adjust the intensity. The clips easily attach to your car's air vents and are light enough that the vent remains adjustable. Febreze says the clips can last up to 30 days under the right conditions, and I found that to be true. Managing Editor David Thomas' wife put one in their family's wagon, and it, too, lasted a month with a few drops of liquid remaining.

These clips lost a few points because they have the highest price tag of all the fresheners I tested. (Look for coupons, people.) Also, the five available scents have names like "thai fruit dragon" and "meadows and rain," which are a bit annoying in their forced extravagance.

Bahama & Co. Air Fresheners

Price: \$3.99

Rating: Acceptable

These fresheners are for those of you who buy things only to please your children or who think Jimmy Buffett is appropriate music for any occasion. These fresheners hang on a string and come in the form of a miniature beach sandal, lei or palm tree-themed pouch. I tested the sandal in a lovely Tahitian vanilla scent. Other available scents include the similarly beach-themed pina coloda, island sun and tropical breeze. The scent was robust for about 15 days, and then it simply became a small shoe on a string that my children thought was swell.

Yankee Candle Car Jar

Price: \$2.99

Rating: Acceptable/Marginal

They're similar to the Little Trees, though not entirely as satisfying. The Car Jar is a hanging piece of cardboard depicting a Yankee Candle in a jar, and it comes in about 25 fragrances. Those that I tested came on too strong initially, were too sweet and fruity-smelling overall, and faded away too quickly. A Car Jar Ultimate is available but was not tested. The Ultimate claims to offer up to four weeks of lasting fragrance, and while that may be true, my guess is that you may not last four weeks if the Ultimate's fragrance is any sweeter and stronger than the regular Car Jar.

Refresh Your Car Scented Oil Wick

Price: \$3.49

Rating: Marginal

This is made by the same folks who gave us the cute little Bahama & Co. mini sandal. Like the Febreze Clip, the Oil Wick attaches to your car's air vent. Unlike the Febreze Clip, this one is made of glass and is so heavy and large that it compromises the utility of the vent and therefore doesn't work that well since it relies on air blowing through the vent to spread the scent. It also leaks, creating a precarious combination of glass and oil in my carload of kids.

Related

[Car Smells Like Teen Spirit? Not Anymore](#)

[More Family News on Cars.com](#)

[More Automotive News on Cars.com](#)

Family

Social Reader

More from Cars.com



How to Transport Your Christmas Tree Safely



Car Smells Like Teen Spirit? Not Anymore



Father's Day Gift Ideas for the Car-Obsessed Dad

Our Company

[About Cars.com](#)

[Contact Cars.com](#)

[Site Map](#)

[Careers](#)

[Fraud Awareness](#)

Our Partner

[Auto.com](#)

[NewCars.com](#)

[RepairPal.com](#)



Powered By Google

EXHIBIT C



Search

Upload

Sign in



How To Install Christmas Tree Air Freshener Haley Certified Center

 Haley Toyota Certified Center

 37

12,188 views

 Add to  Share  More

 45  6

Uploaded on Jan 29, 2011

<http://haleycertified.com/page/servic...> Did you know that there was a science to installing a Christmas tree air freshener? You do now! Haley Toyota Certified Center parts manager, Bob Yarusinsky, demonstrates how to get the most out of your purchase.

SHOW MORE

COMMENTS • 7

 Add a public comment...

Top comments ▾

 **fossilsol69** 3 weeks ago
 Been using these for years. Put one on the stereo volume knob last night and this morning i have melted spot on my veneer and the paint on one of my stereo knobs is peeling off. Beware! There should be a skull and crossbones on packaging as these things contain a very bad chemical sometimes it contains much more than other times. If it can peel the paint off a car it definitely will kill a small child that might lick it.

Reply •  

 **Billy R** 1 year ago
 That would look so bad hanging off the rear view mirror.

Reply • 8  









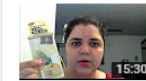

 **AyyGin** 10 months ago
 so they expect me to hang that thing on my mirror with the wrapper still on? lol

Reply •  

 **Softouch468** 1 year ago

Up next

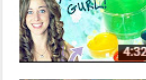
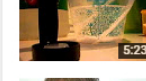
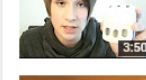
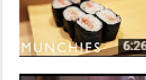
Autoplay 

-  **The Best All-Natural Air Freshener For Your Car!**
Rideshare Genius
74,315 views
-  **Car Freshener Reviews - Yankee Candle, B&W, and more**
Scentmyway
18,076 views
-  **Caravan Palace - Wonderland**
CaravanPalace
Recommended for you
-  **Car Air Freshener Challenge**
Good Mythical Morning
2,551,867 views
-  **Recharge Your Car's Air Freshener with Essential Oil! (Easy, Cheesy Tip)**
CheapGeek
25,056 views
-  **How To Apply Toyota Touch Up Paint Haley Certified Richmond VA**
Haley Toyota Certified Center
29,809 views
-  **Review aromatizante Little Trees - vanilla pride**
Jose Fernando
706 views
-  **NEW CAR MAGIC TREE AIR FRESHENER! (291)**
BARBSTER360
679 views
-  **How To Install Toyota Wiper Blade Inserts Haley Certified Center**
Haley Toyota Certified Center
26,929 views
-  **10 Disneyland Secrets They Don't Want You To Know**
WhatCulture
Recommended for you
-  **Super Easy DIY Gel Air Freshener! - Do It, Gurl**
Gurl.com
367,936 views
-  **My Homemade Airfreshener**
TarotLadyLissa
37,325 views
-  **Stupid Air Fresheners**
danisnotonfire
2,632,065 views
-  **How to Eat Sushi: You've Been Doing it Wrong**
Munchies
Recommended for you
-  **TAMPOPO 5 overeating+subtitles**
DIOGENIS21
Recommended for you



This sucks. It's going to look really bad. They have to come up with a new idea.

Reply · 1



Will Scarlett 2 years ago

The only problem is, once you've pulled the tree out about half-way, it gets kinda difficult to hang without it coming out altogether.

Reply · 1



Justin Crews 2 years ago

youre a geniusand how youd hand the bag would be by the string wow.....you two should collab

Reply · 1



The8TrackChap 2 years ago

How do you hang the bag?



Don't Make Your Home Smell Fresh & Clean DIY Air Fresheners! (Clean My Space)
Clean My Space
399,705 views



DIY Gel Freshener | Gift Idea | Home & Room Decor | ANN LE
Ann Le (Anneorshine)
677,375 views



Walt Disney's Tour of Disneyland
fireurgunz
Recommended for you



The Truth About Air Fresheners! Useful Ways to Keep Your Home Clean & Fresh
Clean My Space
174,866 views



DIY- Air Fresheners- Quick, easy, and Inexpensive!
Aim To Create
2,646,861 views

SHOW MORE



Language: English

Country: Worldwide

Restricted Mode: Off

History

Help

About Press Copyright Creators Advertise Developers +YouTube

Terms Privacy Policy & Safety Send feedback Try something new!