



**Congressional
Research Service**

Informing the legislative debate since 1914

Navy Lasers, Railgun, and Hypervelocity Projectile: Background and Issues for Congress

Ronald O'Rourke
Specialist in Naval Affairs

May 12, 2017

Congressional Research Service

7-5700

www.crs.gov

R44175

Summary

The Navy is currently developing three potential new weapons that could improve the ability of its surface ships to defend themselves against enemy missiles—solid state lasers (SSLs), the electromagnetic railgun (EMRG), and the hypervelocity projectile (HVP).

Any one of these new weapon technologies, if successfully developed and deployed, might be regarded as a “game changer” for defending Navy surface ships against enemy missiles. If two or three of them are successfully developed and deployed, the result might be considered not just a game changer, but a revolution. Rarely has the Navy had so many potential new types of surface-ship missile-defense weapons simultaneously available for development and potential deployment. The HPV in particular has emerged as a program of particular interest to the Department of Defense (DOD), which is exploring the potential for using the weapon across multiple U.S. military services.

Although the Navy in recent years has made considerable progress in developing SSLs, EMRG, and HVP, a number of significant development challenges remain. Overcoming these challenges will likely require years of additional development work, and ultimate success in overcoming them is not guaranteed.

The issue for Congress is whether to approve, reject, or modify the Navy’s funding requests and proposed acquisition strategies for these three potential new weapons. Potential oversight questions for Congress include the following:

- Using currently available approaches for countering anti-ship cruise missiles (ASCMs) and anti-ship ballistic missiles (ASBMs), how well could Navy surface ships defend themselves in a combat scenario against an adversary such as China that has large numbers of ASCMs (including advanced models) and ASBMs? How would this change if Navy surface ships in coming years were equipped with SSLs, EMRG, HVP, or some combination of these systems?
- How significant are the remaining development challenges for SSLs, EMRG, and HVP?
- Are current schedules for developing SSLs, EMRG, and HVP appropriate in relation to remaining development challenges and projected improvements in enemy ASCMs and ASBMs? To what degree are current schedules for developing SSLs, EMRG, or HVP sensitive to annual funding levels?
- When does the Navy anticipate issuing roadmaps detailing its plans for procuring and installing production versions of SSLs, EMRGs, and HVP on specific Navy ships by specific dates?
- Will the kinds of surface ships that the Navy plans to procure in coming years have sufficient space, weight, electrical power, and cooling capability to take full advantage of SSLs (particularly those with beam powers above 200 kW) and EMRG? What changes, if any, would need to be made in Navy plans for procuring large surface combatants (i.e., destroyers and cruisers) or other Navy ships to take full advantage of SSLs and EMRG?
- Are the funding sources for SSLs, EMRG, and HVP in Navy and Defense-Wide research and development accounts sufficiently visible for supporting congressional oversight?

Contents

| | |
|--|----|
| Introduction | 1 |
| Issue for Congress..... | 1 |
| Scope of Report..... | 1 |
| Background | 2 |
| Strategic and Budgetary Context..... | 2 |
| Concern about Survivability of Navy Surface Ships | 2 |
| Depth of Magazine and Cost Exchange Ratio | 3 |
| SSLs, EMRG, and HVP in Brief..... | 4 |
| SSLs | 4 |
| EMRG..... | 12 |
| HVP | 15 |
| Indirectly Improving Ability to Counter ASCMs and ASBMs | 24 |
| Remaining Development Challenges | 24 |
| SSLs | 24 |
| EMRG and HVP | 26 |
| Issues for Congress..... | 27 |
| Potential Oversight Questions..... | 27 |
| Legislative Activity for FY2017..... | 28 |
| Summary of Congressional Action on FY2017 Funding | 28 |
| FY2017 National Defense Authorization Act (H.R. 4909/S. 2943/P.L. 114-328) | 29 |
| House | 29 |
| Senate..... | 31 |
| Conference | 35 |
| FY2017 DOD Appropriations Act (H.R. 5293/S. 3000/H.R. 244 /P.L. 115-31)..... | 37 |
| House (Committee Report) | 37 |
| House (Floor Consideration)..... | 38 |
| Senate..... | 38 |
| Conference | 38 |
| Directed Energy Weapon Systems Acquisition Act of 2016 (H.R. 4964/S. 2778)..... | 39 |
| House | 39 |
| Senate..... | 40 |

Figures

| | |
|---|----|
| Figure 1. Laser Weapon System (LaWS) on USS Ponce | 7 |
| Figure 2. Laser Weapon System (LaWS) on USS Ponce | 7 |
| Figure 3. Laser Weapon System (LaWS) on USS Ponce | 8 |
| Figure 4. Laser Weapon System Demonstrator (LWSD) on Self Defense Test Ship | 9 |
| Figure 5. Laser Weapon System Demonstrator (LWSD) on Self Defense Test Ship | 10 |
| Figure 6. ONR Graphic of LWSD Components..... | 11 |
| Figure 7. Industry-Built EMRG Prototype Demonstrator | 13 |
| Figure 8. Industry-Built EMRG Prototype Demonstrator | 13 |
| Figure 9. EMRG Prototype Demonstrator Installed on a JHSV..... | 14 |
| Figure 10. Photograph Showing HVP | 17 |

Figure 11. HVP..... 18
Figure 12. HVP Launch Packages..... 19
Figure 13. HVP Application to Various Launchers 20
Figure 14. Navy Slide Depicting Operations Against Various Target Types..... 21
Figure 15. Development Challenges for SSLs 25
Figure 16. Development Challenges for EMRG 26

Tables

Table 1. Summary of Congressional Action on FY17 Funding..... 28

Appendixes

Appendix. Potential Advantages and Limitations of Shipboard Lasers 43

Contacts

Author Contact Information 45

Introduction

Issue for Congress

This report provides background information and issues for Congress on three potential new weapons that could improve the ability of Navy surface ships to defend themselves against enemy missiles—solid state lasers (SSLs), the electromagnetic railgun (EMRG), and the hypervelocity projectile (HVP).¹

Any one of these new weapon technologies, if successfully developed and deployed, might be regarded as a “game changer” for defending Navy surface ships against enemy missiles. If two or three of them are successfully developed and deployed, the result might be considered not just a game changer, but a revolution. Rarely has the Navy had so many potential new types of surface-ship missile-defense weapons simultaneously available for development and potential deployment. Although the Navy in recent years has made considerable progress in developing SSLs, EMRG, and HVP, a number of significant development challenges remain. The HPV in particular has emerged as a program of particular interest to the Department of Defense (DOD), which is exploring the potential for using the weapon across multiple U.S. military services.

The issue for Congress is whether to approve, reject, or modify the Navy’s funding requests and proposed acquisition strategies for these three potential new weapons. Congress’ decisions on this issue could affect future Navy capabilities and funding requirements and the defense industrial base.

Scope of Report

SSLs are being developed by multiple parts of DOD, not just the Navy. SSLs, EMRG, and HVP, moreover, have potential application to military aircraft and ground forces equipment, not just surface ships. And SSLs, EMRG, and HVP can be used for missions other than defending against ASCMs and ASBMs.² This report focuses on Navy efforts to develop SSLs, EMRG, and HVP for potential use in defending Navy surface ships against ASCMs and ASBMs. It supersedes an earlier CRS report that provided an introduction to potential Navy shipboard lasers.³

Note that while fictional depictions of laser weapons in popular media often show them being used to attack targets at long ranges, the SSLs currently being developed by the Navy for potential shipboard use would be used to counter targets at short ranges of about a mile to perhaps a few miles.

¹ Railgun is also spelled as rail gun; EMRG is also abbreviated as EM railgun; hypervelocity is also spelled as hyper-velocity or hyper velocity.

² As discussed later in the report, the Navy is exploring the potential for using shipboard lasers to counter small boats and unmanned aerial vehicles (UAVs), and EMRG can be used to attack land targets.

³ CRS Report R41526, *Navy Shipboard Lasers for Surface, Air, and Missile Defense: Background and Issues for Congress*, by Ronald O’Rourke. This earlier CRS report has been archived and remains available as a supplementary reference source on potential Navy shipboard lasers.

Background

Strategic and Budgetary Context

For an overview of the strategic and budgetary context in which the programs covered in this report and other Navy programs may be considered, see CRS Report RL32665, *Navy Force Structure and Shipbuilding Plans: Background and Issues for Congress*, by Ronald O'Rourke.

Concern about Survivability of Navy Surface Ships

Although Navy surface ships have a number of means for defending themselves against anti-ship cruise missiles (ASCMs) and anti-ship ballistic missiles (ASBMs),⁴ some observers are concerned about the survivability of Navy surface ships in potential combat situations against adversaries, such as China, that are armed with advanced ASCMs and with ASBMs.⁵ Concern about this issue has led some observers to conclude that the Navy's surface fleet in coming years might need to avoid operating in waters that are within range of these weapons, or that the Navy might need to move toward a different fleet architecture that relies less on larger surface ships and more on smaller surface ships and submarines.⁶ Such changes in Navy operating areas and fleet architecture could substantially affect U.S. military strategy and the composition of the Navy's shipbuilding expenditures.

Navy surface fleet leaders in early 2015 announced a new organizing concept for the Navy's surface fleet called distributed lethality. Under distributed lethality, offensive weapons such as ASCMs are to be distributed more widely across all types of Navy surface ships, and new operational concepts for Navy surface ship formations are to be implemented. The aim of distributed lethality is to boost the surface fleet's capability for attacking enemy ships and make it less possible for an enemy to cripple the U.S. fleet by concentrating its attacks on a few very-high-value Navy surface ships (particularly the Navy's aircraft carriers).⁷ Perspectives on whether

⁴ These include the following: operating ships in ways that make it hard for others to detect and accurately track Navy ships; jamming or destroying enemy targeting sensors; interfering with the transmission of targeting data from sensors to weapon launchers; attacking weapon launchers (which can land-based launchers or launchers on surface ships, submarines, or aircraft); and countering ASCMs and ASBMs headed toward Navy ships. Navy measures for countering ASCMs and ASBMs headed toward Navy ships include the following: jamming a missile's guidance system; using decoys of various kinds to lure enemy missiles away from Navy ships; and shooting down enemy missiles with surface-to-air missiles and the Phalanx Close-In Weapon System (CIWS), which is essentially a radar-controlled Gatling gun. Employing all these measures reflects a long-standing Navy approach of creating a multi-layered defense against enemy missiles, and of attacking the enemy's "kill chain" at multiple points so as to increase the chances of breaking the chain. (The kill chain is the sequence of steps that an enemy must complete to conduct a successful missile attack on a Navy ship. This sequence includes, at a basic level of description, detecting and tracking the Navy ship, passing that information from sensors to the weapon launcher, launching the weapon, and guiding the weapon all the way to the Navy ship. Interfering with any one of these actions can break the kill chain and thereby prevent or defeat the attack.)

⁵ See, for example, Andrew F. Krepinevich, *Maritime Warfare in a Mature Precision-Strike Regime*, Washington, Center for Strategic and Budgetary Assessments, 2014, 128 pp. For more on China's ASCMs and ASBMs, see CRS Report RL33153, *China Naval Modernization: Implications for U.S. Navy Capabilities—Background and Issues for Congress*, by Ronald O'Rourke.

ASCMs and ASBMs are not the only reasons that some observers are concerned about the future survivability of U.S. Navy surface ships in combat situations; observers are also concerned about threats to U.S. Navy surface ships posed by small boats, mines, and torpedoes.

⁶ See, for example, Phillip E. Pournelle, "The Deadly Future of Sea Control," *U.S. Naval Institute Proceedings*, July 2015: 26-31.

⁷ See, for example, Thomas Rowden, Peter Gumataotao, and Peter Fanta, "Distributed Lethality," *U.S. Naval Institute* (continued...)

it would be cost effective to spend money spreading offensive weapons across a wider array of Navy surface ships might be influenced by views on whether those surface ships can adequately defend themselves against enemy missiles.

Depth of Magazine and Cost Exchange Ratio

Two key limitations that Navy surface ships currently have in defending themselves against ASCMs and ASBMs are limited depth of magazine and unfavorable cost exchange ratios. Limited depth of magazine refers to the fact that Navy surface ships can use surface-to-air missiles (SAMs) and their Close-in Weapon System (CIWS) Gatling guns to shoot down only a certain number of enemy unmanned aerial vehicles (UAVs) and anti-ship missiles before running out of SAMs and CIWS ammunition⁸—a situation (sometimes called “going Winchester”), that can require a ship to withdraw from battle, spend time travelling to a safe reloading location (which can be hundreds of miles away),⁹ and then spend more time traveling back to the battle area.

Unfavorable cost exchange ratios refer to the fact that a SAM used to shoot down a UAV or anti-ship missile can cost the Navy more (perhaps much more) to procure than it cost the adversary to build or acquire the UAV or anti-ship missile. In the FY2016 defense budget, procurement costs for Navy SAMs range from about \$900,000 per missile to several million dollars per missile, depending on the type.¹⁰

In combat scenarios against an adversary with a limited number of UAVs and anti-ship missiles, an unfavorable cost exchange ratio can be acceptable because it saves the lives of Navy sailors and prevents very expensive damage to Navy ships. But in combat scenarios (or an ongoing military capabilities competition) against a country such as China that has many UAVs and anti-ship missiles and a capacity for building or acquiring many more, an unfavorable cost exchange ratio can become a very expensive—and potentially unaffordable—approach to defending Navy

(...continued)

Proceedings, January 2015: 18-23; Sam LaGrone, “SNA: Navy Surface Leaders Pitch More Lethal Ships, Surface Action Groups,” *USNI News*, January 14, 2015; Kris Osborn, “Navy Unveils New Surface Warfare Strategy,” *Military.com*, January 14, 2015; Sydney J. Freedberg Jr., “‘If It Floats, It Fights’: Navy Seeks ‘Distributed Lethality,’” *Breaking Defense*, January 14, 2015; Mike McCarthy and Megan Eckstein, “Navy Eyeing A ‘Hunter Killer’ Surface Fleet, Would Require Upgunning Existing Ship Fleets,” *Defense Daily*, January 15, 2015: 1-3; Richard Scott, “Offensive Language: USN Sets Out Surface Firepower Strategy,” *Jane’s International Defence Review*, May 2015: 42-47; Megan Eckstein, “Navy Studying Implications of Distributed Lethality in Wargames Series,” *USNI News*, July 9, 2015; Lara Seligman, “Navy Establishes Task Force To Study Impact of Distributed lethality,” *Inside the Navy*, July 10, 2015.

⁸ Navy cruisers have 122 missile cells; Navy destroyers have 90 or 96 missile cells. Some of these cells are used for storing and launching Tomahawk land attack cruise missiles or anti-submarine rockets. The remainder are available for storing and launching SAMs. A Navy cruiser or destroyer might thus be armed with a few dozen or several dozen SAMs for countering ASCMs and ASBMs. Countering ASCMs or ASBMs with SAMs might sometimes require shooting two SAMs at each ASCM or ASBM.

⁹ The missile cells on a Navy cruiser or destroyers are clustered together in an installation called a Vertical Launch System (VLS). VLS cells cannot be reloaded while the ship is underway; a ship needs to return to a port or a calm anchorage to reload its VLS.

¹⁰ Unit procurement costs for ship-launched SAMs in the FY2016 are as follows: about \$900,000 for the Rolling Airframe Missile (RAM), about \$1.1 million to about \$1.5 million for the Evolved Sea Sparrow Missile (ESSM), about \$3.9 million for the SM-6 Block 1 missile, about \$14 million for the SM-3 Block 1B missile, and more than \$20 million for the SM-3 Block IIA missiles. RAM and ESSM are short-range missiles for defense against aircraft and ASCMs. The SM-6 Block 1 is a medium-range missile used for both defense against aircraft and ASCMs, and terminal (i.e., endo-atmospheric) defense against theater-range ballistic missiles. The SM-3 Block 1B and SM-3 Block IIA are used for mid-course (i.e., exo-atmospheric) defense against theater-range ballistic missiles.

surface ships against UAVs and anti-ship missiles, particularly in a context of constraints on U.S. defense spending and competing demands for finite U.S. defense funds.

SSLs, EMRG, and HVP offer a potential for dramatically improving depth of magazine and the cost exchange ratio:

- **Depth of magazine.** SSLs are electrically powered, drawing their power from the ship's overall electrical supply, and can be fired over and over, indefinitely, as long as the SSL continues to work and the ship has fuel to generate electricity. The EMRG's projectile and the HVP (which are one and the same—see next section) can be stored by the hundreds in a Navy surface ship's weapon magazine.¹¹
- **Cost exchange ratio.** An SSL can be fired for a marginal cost of less than one dollar per shot (which is the cost of the fuel needed to generate the electricity used in the shot), while the EMRG's projectile/HVP has an estimated unit procurement cost of about \$25,000.¹²

For additional discussion of the strategic and budgetary context in which the programs discussed in this report and other Navy programs may be considered, see CRS Report RL32665, *Navy Force Structure and Shipbuilding Plans: Background and Issues for Congress*, by Ronald O'Rourke.

SSLs, EMRG, and HVP in Brief

SSLs

Overview

The Navy in recent years has leveraged both significant advancements in industrial SSLs and decades of research and development work on military lasers done by other parts of DOD to make substantial progress toward deploying high-energy SSLs¹³ on Navy surface ships. Navy surface ships would use high-energy SSLs initially for countering small boats, UAVs, and potentially in the future for countering ASCMs and ASBMs as well.¹⁴ High-energy SSLs on Navy ships would be short-range defensive weapons—they would counter targets at ranges of about one mile to perhaps eventually a few miles.¹⁵

¹¹ In July 2015, the Navy issued a request for information (RFI) to industry for the fabrication of a prototype EMRG mount that would store a minimum of 650 rounds. (RFI for Fabrication of Prototype Mount for Naval Railgun, Solicitation Number: N00024-15-R-4132, FedBizOpps.gov, July 29, 2015. See also Justin Doubleday, "Navy Developing Integrated Mount For Electromagnetic Railgun," *Inside the Navy*, July 31, 2015.)

¹² Sources for cost of HVP: David Martin, "Navy's Newest Weapon Kills at Seven Times the Speed of Sound," CBS News (cbsnews.com), April 7, 2014; Kris Osborn, "Navy Will Test its Electromagnetic Rail Gun aboard DDG 1000," *DefenseTech*, April 15, 2015.

¹³ In discussions of potential Navy shipboard lasers, a high-energy laser is generally considered to be a laser with a beam power of at least 10 kilowatts (kW).

¹⁴ In general, lasers would counter small boats and missiles by heating and burning holes in their skins, and causing thermal damage to their interiors. Lasers can also be used to "dazzle" (i.e., interfere with) electro-optical sensors on a boat or missile.

¹⁵ The Navy has also performed research and development work on a different kind of laser, called the free electron laser (FEL). In recent years, Navy research and development work on potential shipboard lasers has shifted more to SSLs. For background information on the FEL, see CRS Report R41526, *Navy Shipboard Lasers for Surface, Air, and (continued...)*

In addition to a low marginal cost per shot and deep magazine, potential advantages of shipboard lasers include fast engagement times, an ability to counter radically maneuvering missiles, an ability to conduct precision engagements, and an ability to use lasers for graduated responses ranging from detecting and monitoring targets to causing disabling damage. Potential limitations of shipboard lasers relate to line of sight; atmospheric absorption, scattering, and turbulence (which prevent shipboard lasers from being all-weather weapons); an effect known as thermal blooming that can reduce laser effectiveness; countering saturation attacks; possible adversary use of hardened targets and countermeasures; and risk of collateral damage, including damage to aircraft and satellites and permanent damage to human eyesight, including blinding. These potential advantages and limitations are discussed in greater detail in the **Appendix**.

Selected Key Developments

Key developments in the Navy's high-energy SSL development effort include the following:

- Between 2009 and 2012, the Navy successfully tested a prototype SSL called the Laser Weapon System (LaWS) against UAVs in a series of engagements that took place initially on land and subsequently on a Navy ship at sea.
- Between 2010 and 2011, the Navy tested another prototype SSL called the Maritime Laser Demonstration (MLD) in a series of tests that culminated with an MLD installed on a Navy ship successfully engaging a small boat.
- In April 2013, the Navy announced that it planned to install LaWS on the USS *Ponce* (pronounced pon-SAY)—a converted amphibious ship that is operating in the Persian Gulf as an interim Afloat Forward Staging Base (AFSB[I])¹⁶—to conduct evaluation of shipboard lasers in an operational setting against swarming boats and swarming UAVs.¹⁷ The system was installed in August 2014 (see **Figure 1**, **Figure 2**, and **Figure 3**).
- In March 2014, it was reported that the Navy anticipated moving to a shipboard laser program of record in “the FY2018 time frame” and achieving an initial operational capability (IOC) with a shipboard laser in FY2020 or FY2021.¹⁸

(...continued)

Missile Defense: Background and Issues for Congress, by Ronald O'Rourke.

¹⁶ An AFSB operates as a “mother ship” for Navy helicopter and small boat operations. The *Ponce* is serving as an interim AFSB pending the arrival of a new AFSB that is currently being built.

¹⁷ “Navy Leaders Announce Plans for Deploying Cost-Saving Laser Technology,” *Navy News Service*, April 8, 2013; Thom Shanker, “Navy Deploying Laser Weapon Prototype Near Iran,” *New York Times*, April 9, 2013: 4; Mike McCarthy, “Navy Deploying Laser For Taking Out Drones,” *Defense Daily*, April 9, 2013; Graham Warwick, “U.S. Navy Planning Gulf Deployment For Laser Weapon,” *Aerospace Daily & Defense Report*, April 9, 2013: 6; Megan Eckstein, “Navy-Built Laser Weapon System Will Begin Demo On *Ponce* In Early 2014,” *Inside the Navy*, April 15, 2013. See also Lara Seligman, “Navy-built LaWS To Begin Demo This Summer, IOC Slated For FY-20-21,” *Inside the Navy*, March 24, 2014; Office of Naval Research, “All Systems Go: Navy's Laser Weapon Ready for Summer Deployment,” *Navy News Service*, April 7, 2014.

Swarming refers to the use of boats and UAVs in large numbers, or swarms, in an attempt to confuse and overwhelm a target ship's defensive systems.

¹⁸ Lara Seligman, “Navy-built LaWS To Begin Demo This Summer, IOC Slated For FY-20-21,” *Inside the Navy*, March 24, 2014. A program of record, or POR, is a term sometimes used by DOD officials that means, in general, a program in the Future Years Defense Plan (FYDP) that is intended to provide a new, improved, or continuing materiel, weapon, or information system or service capability in response to an approved need. The term is sometimes used to refer to a program in a service's budget for procuring and deploying an operational weapon system, as opposed to a research and development effort that might or might not eventually lead to procurement and deployment of an (continued...)

- In December 2014, the Navy declared LaWS on the Ponce to be an “operational” system.¹⁹
- In January 2016, the Navy stated that it anticipated releasing a directed energy weapon roadmap in February 2016.²⁰ (As of October 21, 2016, such a roadmap had not been released.)

SSL Technology Maturation (SSL-TM) Program

LaWS has a reported beam power of 30 kilowatts (kW),²¹ which is strong enough to counter small boats and UAVs. As a follow-on effort to LaWS and MLD, the Navy initiated the SSL Technology Maturation (SSL-TM) program, in which industry teams led by BAE Systems, Northrop Grumman, and Raytheon, among others, competed to develop a shipboard laser with a beam power of 100 kW to 150 kW, which would provide increased effectiveness against small boats and UAVs.²² Boosting beam power further—to something like 200 kW or 300 kW—could

(...continued)

operational weapon system.

¹⁹ A December 11, 2014, press report stated

The Navy’s first-of-a-kind laser deployed on a vessel sailing in the Persian Gulf has been declared operational and can be used by the crew to defend itself against potential threats, the service’s head of the Office of Naval Research said on Wednesday [December 10, 2014].

Rear Adm. Matthew Klunder told reporters on a conference call that Central Command has been green lighted to use the laser in the event of a threat, approval that has been passed along to the ship’s commanding officer. The 30-kilowatt laser, known as the Laser Weapon System, or LaWS, was installed on the USS Ponce in August [2014].

The ship later departed for the Persian Gulf and the LaWS successfully carried out operational testing recently by striking a fast attack boat and drone, Klunder said, adding that this marks the “historic” first ever operational deployment of a directed energy weapon.

(Mike McCarthy, “Navy Authorized To Use Ship-Based Laser In Battle,” *Defense Daily*, December 11, 2014: 3. See also Sam LaGrone, “U.S. Navy Allowed to Use Persian Gulf Laser for Defense,” *USNI News*, December 10, 2014; Philip Ewing, “Navy Declares Laser Weapon ‘Operational,’” *Politico Pro (Pro Defense Report)*, December 10, 2014.)

The Navy testified on February 24, 2016, that

the Solid State Laser Quick Reaction Capability (SSL-QRC) was fielded as a science and technology demonstration aboard the USS PONCE. It was successfully demonstrated as an effective weapon system and was subsequently transitioned to the fleet in the Central Command area of responsibility and is now an operational system.

(Statement of Rear Admiral Mathias W. Winter, United States Navy, Chief of Naval Research, Before the Emerging Threats and Capabilities Subcommittee of the House Armed Services Committee on The Fiscal Year 2017 Budget Request, February 24, 2016, p. 15.)

²⁰ Justin Doubleday, “Winter: Navy Directed-Energy Strategy To Be Released This Month,” *Inside the Navy*, February 1, 2016.

²¹ See, for example, Mike McCarthy, “Navy Authorized To Use Ship-Based Laser In Battle,” *Defense Daily*, December 11, 2014: 3.

²² For more on the SSL-TM program, see Office of Naval Research, “Solid-State Laser Technology Maturation Program,” accessed August 11, 2015, at <http://www.onr.navy.mil/Media-Center/Fact-Sheets/Solid-State-Laser-Technology-Maturation-Program.aspx>; Office of Naval Research, “Solid State Laser Technology Maturation Program,” September 2012, accessed August 11, 2015, at <http://www.onr.navy.mil/~media/Files/Fact-Sheets/35/Solid-State-Laser-Technology-Maturation-Program-2012-a.ashx>; Office of Naval Research, “Research and Development/Technology Maturation of Solid State High Power Laser Weapon Systems, Subsystems, and/or Components for Surface Navy, USN, Broad Agency Announcement (BAA),” ONR BAA # 12-019, 2012, accessed August 11, 2015, at <http://www.onr.navy.mil/~media/files/funding-announcements/baa/2012/12-019.ashx>; Future Force, “Developing a High-Energy Laser for the Navy,” January 23, 2015, accessed August 11, 2015, at (continued...)

permit a laser to counter at least some ASCMs. Even stronger beam powers—on the order of at least several hundred kW, if not one megawatt (MW) or more—could improve a laser’s effectiveness against ASCMs and enable it to counter ASBMs.²³

Figure 1. Laser Weapon System (LaWS) on USS Ponce



Source: Navy photograph dated November 16, 2014, accompanying David Smalley, “Historic Leap: Navy Shipboard Laser Operates in Arabian Gulf,” *Navy News Service*, December 10, 2014, accessed August 12, 2015, at http://www.navy.mil/list_all.asp?id=84805.

Figure 2. Laser Weapon System (LaWS) on USS Ponce



Source: Navy photograph dated November 17, 2014, accompanying David Smalley, “Historic Leap: Navy Shipboard Laser Operates in Arabian Gulf,” *Navy News Service*, December 10, 2014, accessed August 12, 2015, at http://www.navy.mil/list_all.asp?id=84805.

(...continued)

<http://futureforce.navylive.dodlive.mil/2015/01/high-energy-laser/>.

²³ For additional discussion, see CRS Report R41526, *Navy Shipboard Lasers for Surface, Air, and Missile Defense: Background and Issues for Congress*, by Ronald O'Rourke, particularly the section entitled “Required Laser Power Levels for Countering Targets” and Appendix A on “Laser Power Levels Required to Counter Targets.”

Figure 3. Laser Weapon System (LaWS) on USS Ponce



Source: Navy photograph dated November 16, 2014, accompanying David Smalley, “Historic Leap: Navy Shipboard Laser Operates in Arabian Gulf,” *Navy News Service*, December 10, 2014, accessed August 12, 2015, at http://www.navy.mil/list_all.asp?id=84805.

On October 22, 2015, DOD announced that it had selected Northrop Grumman as the winner of the SSL-TM competition. DOD’s contract-award announcement stated:

Northrop Grumman Space and Mission Systems Corp., Redondo Beach, California, is being awarded a \$53,151,809 cost-plus-fixed-fee contract for the Solid State High Power Laser Weapon System Demonstrator (LWSD) program.... The Office of Naval Research seeks to continue the advancement of SSL weapon system designs, architectures, and component technologies. The government believes that improvements in lethality may be achieved through maturation and optimization of a variety of system characteristics, including laser power, beam quality, beam director architecture, and other physical and optical aspects of the laser, beam director, and system design. Leveraging our experience and internal investments, the Northrop Grumman team is ready to fully support the three phases of the LWSD program. This contract contains options, which if exercised, will bring the contract value to \$91,057,597. Work will be performed in Redondo Beach,

California, and is expected to be completed Oct. 21, 2016. If options are exercised, work will continue through July 7, 2018.... This contract was competitively procured under the Office of Naval Research broad agency announcement 15-0005 entitled “Solid State, High Power Laser Weapon System Demonstrator (LWSD) Design, Development and Demonstration for Surface Navy, USN.” Six proposals were received in response to this solicitation.²⁴

A December 22, 2015, Northrop Grumman news release about the October 22, 2016, contract award stated:

During Phase 1 of the LWSD contract, Northrop Grumman will develop a detailed design for the new system. Phase 2 will include assembly and ground test of the system, while Phase 3 will comprise at-sea testing of the system aboard the Navy's Self Defense Test Ship (SDTS). The Navy will lead this testing with Northrop Grumman providing technical support. The SDTS is the former USS Paul F. Foster (DD-964).

According to Renard, Northrop Grumman's LWSD is well suited to support the Navy's planned initial testing on the SDTS. The company has designed its system to be installed, however, with minimal modification or additional costs, for demonstration on the Navy's DDG-51 FLT II class destroyers.²⁵

Figure 4 shows an artist's rendering of LWSD installed on the Navy's Self Defense Test Ship (the USS *Paul F. Foster* [DD-964], an old Spruance [DD-963] class destroyer).

Figure 4. Laser Weapon System Demonstrator (LWSD) on Self Defense Test Ship

Artist's rendering



Source: Cropped version of image accessed on March 18, 2016, at <http://media.globenewswire.com/cache/189/hires/39412.jpg>.

²⁴ DOD contract award announcements for October 22, 2015, accessed December 18, 2015, at: <http://www.defense.gov/News/Contracts/Contract-View/Article/625630>.

²⁵ “US Navy Selects Northrop Grumman to Design and Produce Shipboard Laser Weapon System Demonstrator,” December 22, 2015, accessed March 18, 2016, at: http://www.globenewswire.com/newsarchive/noc/press/pages/news_releases.html?d=10158731. See also Richard Scott, “Northrop Grumman To Build on MLD for SSL Demonstrator,” *IHS Jane's International Defence Review*, February 2016: 5.

Figure 5 is a detail from the previous photo.

Figure 5. Laser Weapon System Demonstrator (LWSD) on Self Defense Test Ship
Artist's rendering

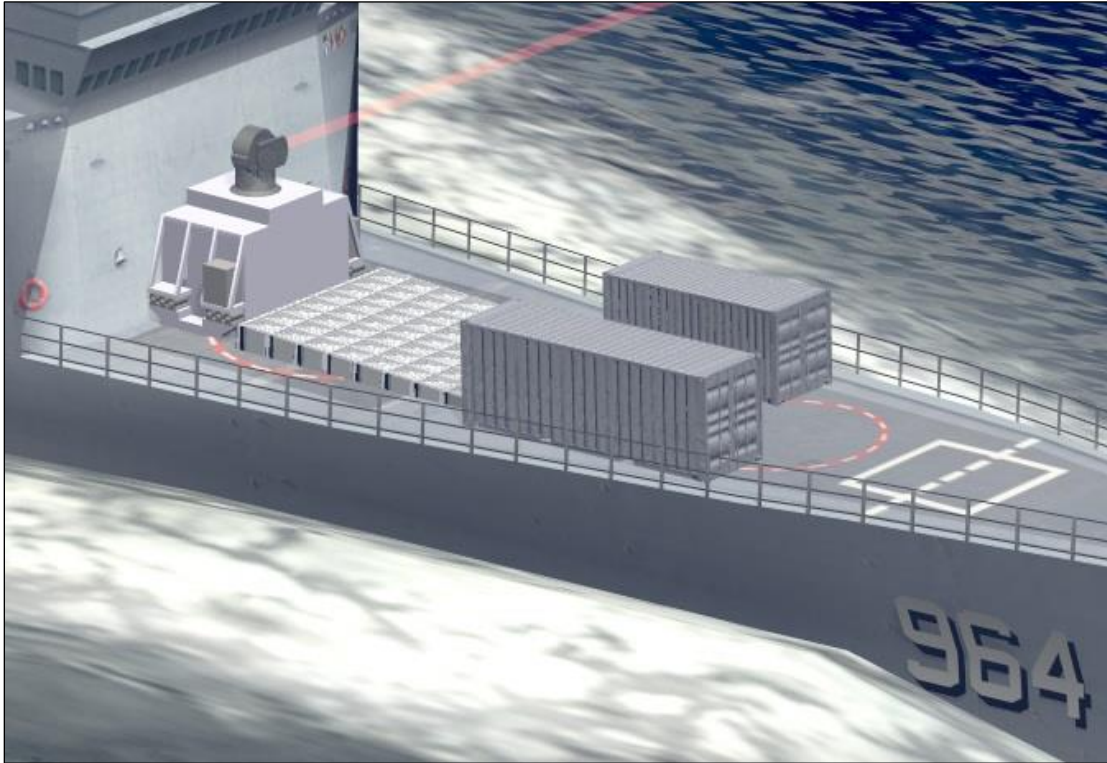

Source: Cropped version of image accessed on March 18, 2016, at <http://media.globenewswire.com/cache/189/hires/39412.jpg>.

A January 23, 2017, press report stated:

The U.S. Navy is moving at warp speed to develop lasers with more lethality, precision and power sources as a way to destroy attacking missiles, drones aircraft and other threats.

"We're doing a lot more with lasers," Rear Adm. Ronald Boxall, director, Surface Warfare Division, said earlier this month at the annual Surface Naval Association national symposium.

The Navy plans to fire a 150-kw weapon off a test ship within a year, he said. "Then a year later, we'll have that on a carrier or a destroyer or both."...

"This system employs multi-spectral target detection and track capabilities as well as an advanced off-axis beam director with improved fiber laser technologies to provide extended target engagement ranges. Improvements of high power fiber lasers used to form the laser beam enable the increased power levels and extended range capabilities. Lessons learned, operating procedures, updated hardware and software derived from previous systems will be incorporated in this demonstration," Dr. Tom Beutner, director

of the Air Warfare and Weapons branch, Office of Naval Research, told Scout Warrior in a written statement at the time of the contract announcement.²⁶

Figure 6 is an Office of Naval Research (ONR) graphic illustration of the LWSD’s major components.

Figure 6. ONR Graphic of LWSD Components

Artist’s rendering

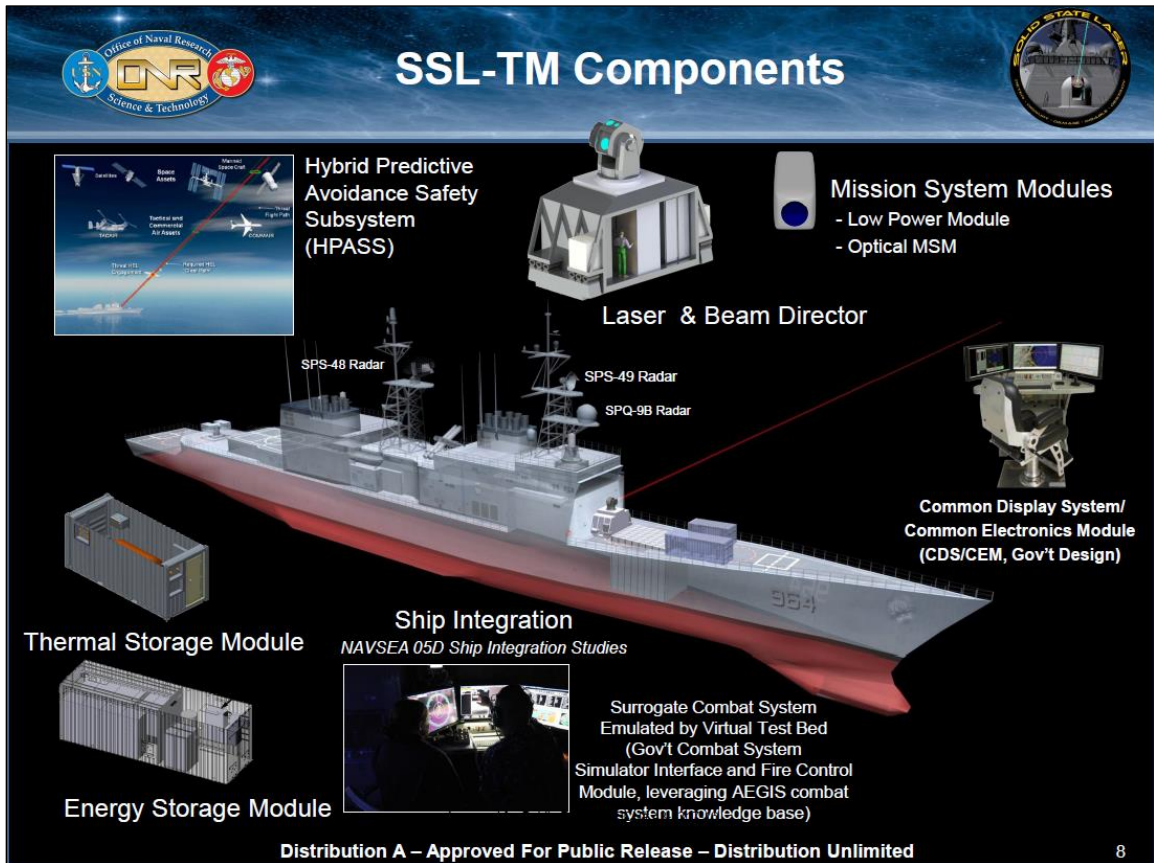

Source: Slide from February 2016 ONR briefing to CRS on SSL-TM program, received from Navy Office of Legislative Affairs February 26, 2016.

Directed Energy Roadmap

A July 28, 2015, press report stated:

[Secretary of the Navy Ray] Mabus said he would release a DE [directed energy]²⁷ roadmap this fall that “charts our course for research, development, and fielding of high power radio frequency weapons, lasers, and directed energy countermeasures. And I will

²⁶ Michael Fabey and Kris Osborn, “Navy to Fire 150Kw Ship Laser Weapon From Destroyers, Carriers,” *Scout Warrior*, January 23, 2017.

²⁷ Lasers and another class of weapons called high-power microwave (HPM) weapons are referred to collectively as directed-energy weapons because they achieve their effects by directing electromagnetic energy at their targets.

follow it up with my guidance to the Program Objective Memorandum for [Fiscal Year 2018],²⁸ which, importantly, establishes a resource sponsor and a program of record.”...

Also meant to help quicken the pace of progress, the Office of Naval Research will take lessons learned from the [USS] Ponce to inform the Solid State Laser Technology Maturation program that aims to produce a 100-150 kilowatt laser prototype for at-sea testing in 2018, or sooner if possible. Rear Adm. Bryant Fuller, Naval Sea Systems Command (NAVSEA) chief engineer, said... that everything the Navy learned about rules of engagement and how to use LaWS in an operational environment would apply to larger laser weapons as well. Leveraging the operational knowledge Ponce gained will help the Navy field whatever comes out of the SSL-TM effort much more rapidly.

In the meantime, Mabus said the Laser Weapon System (LaWS) will continue its work in the Middle East after early success led officials to extend its deployment.²⁹

As of October 21, 2016, a directed energy roadmap had not been released.

EMRG

In addition to SSLs, the Navy since 2005 has been developing EMRG, a cannon that uses electricity rather than chemical propellants (i.e., gunpowder charges) to fire a projectile.³⁰ In EMRG, “magnetic fields created by high electrical currents accelerate a sliding metal conductor, or armature, between two rails to launch projectiles at [speeds of] 4,500 mph to 5,600 mph,”³¹ or roughly Mach 5.9 to Mach 7.4 at sea level.³² Like SSLs, EMRG draws its power from the ship’s overall electrical supply.³³ The Navy originally began developing EMRG as a naval surface fire support (NSFS) weapon for supporting U.S. Marines operating ashore, but subsequently determined that the weapon also has potential for defending against ASCMs and ASBMs.³⁴ In response to Section 243 of the FY2012 National Defense Authorization Act (H.R. 1540/P.L. 112-81 of December 31, 2011), the Navy in September 2012 submitted to the congressional defense committees a report on the EMRG development effort.³⁵

Following tests with early Navy-built EMRG prototypes, the Navy funded the development of two industry-built EMRG prototype demonstrators, one by BAE Systems and the other by General Atomics (see **Figure 7** and **Figure 8**).

²⁸ The Program Objective Memorandum (POM) is an internal DOD document that guides the preparation of a budget for a particular fiscal year.

²⁹ Megan Eckstein, “Mabus: Adversaries Showing Interest in Directed Energy; Navy Needs to Move Faster,” *USNI News*, July 28, 2015.

³⁰ Because it uses electricity rather than a powder charge to accelerate the projectile, Navy officials sometimes refer to EMRG as a launcher rather than a gun or cannon.

³¹ Grace Jean, “With a Bang, Navy Begins Tests on EM Railgun Prototype Launcher,” Navy News Service, February 28, 2012, accessed August 12, 2015, at http://www.navy.mil/submit/display.asp?story_id=65577.

³² The speed of sound in air (i.e., Mach 1), varies with altitude; at sea level, it is approximately 761 miles an hour. (See for example, the table entitled “Speed of Sound at Different Altitudes,” accessed August 12, 2015, at <http://www.fighter-planes.com/jetmach1.htm>.)

³³ Unlike SSLs, however, EMRG is not a directed energy weapon, because it achieves its effects by firing a physical projectile at the target, not by directing electromagnetic energy at the target. See also footnote 27.

³⁴ For a recent article discussing the use of EMRG in countering ASCMs and ASBMs, see Sam LaGrone, “Navy Wants Rail Guns to Fight Ballistic and Supersonic Missiles Says RFI,” *USNI News*, January 5, 2015.

³⁵ U.S. Navy, *Electromagnetic Railgun System: Final Report to the Congressional Defense Committees*, August 2012, with cover letters dated September 18, 2012. For a press report discussing the Navy’s report to Congress, see Dan Taylor, “Stackley: Navy Identifies Four Technical Hurdles To Railgun Development,” *Inside the Navy*, November 19, 2012.

Figure 7. Industry-Built EMRG Prototype Demonstrator
BAE prototype



Source: Navy photograph dated July 8, 2014, associated with Office of Naval Research Public Affairs, "From Research to Railgun: Revolutionary Weapon at Future Force EXPO," *Navy News Service*, January 13, 2015, accessed August 12, 2015, at http://www.navy.mil/submit/display.asp?story_id=85166.

Figure 8. Industry-Built EMRG Prototype Demonstrator
General Atomics prototype



Source: Navy photograph dated July 8, 2014, accessed August 12, 2015, at http://www.navy.mil/view_image.asp?id=180994.

The two industry-built prototypes are designed to fire projectiles at energy levels of 20 to 32 megajoules,³⁶ which is enough to propel a projectile 50 to 100 nautical miles.³⁷ (Such ranges might refer to using the EMRG for NSFS missions. Intercepts of ASCMs and ASBMs might take place at much shorter ranges.) The Navy began evaluating the two industry-built prototypes in 2012.

In April 2014, the Navy announced that it plans to temporarily install a prototype EMRG aboard a Navy Joint High Speed Vessel (JHSV) in FY2016, for use in at-sea tests.³⁸ **Figure 9** is an artist's rendering of that installation.

Figure 9. EMRG Prototype Demonstrator Installed on a JHSV

Artist's rendering

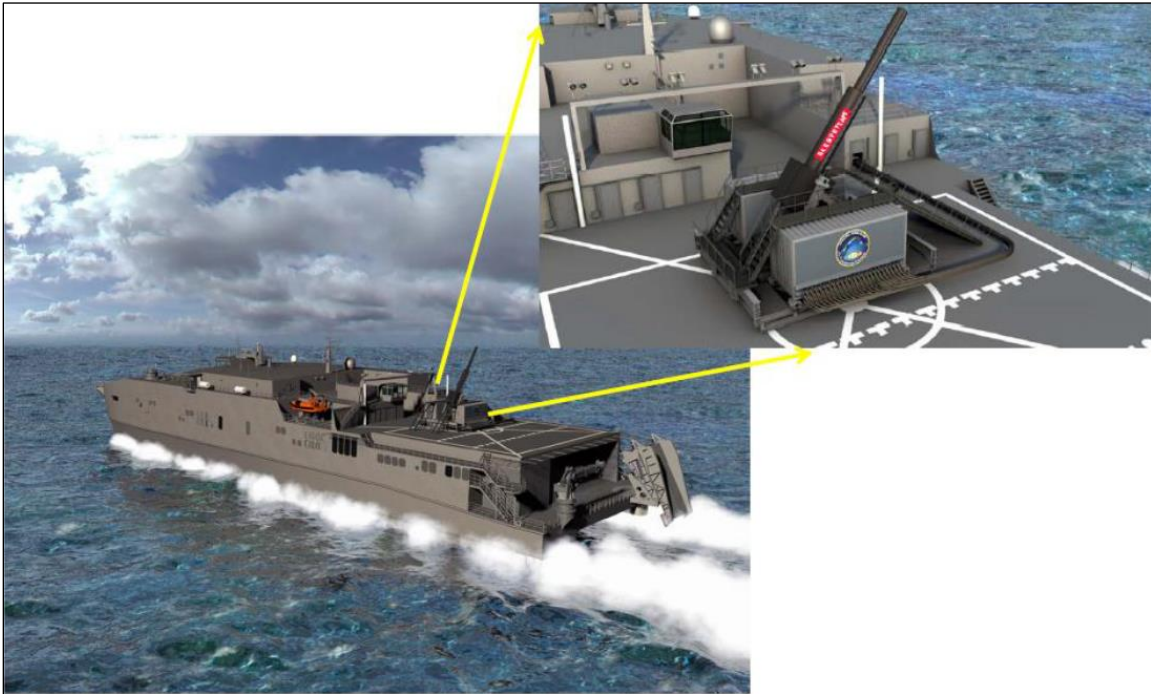

Source: Briefing slide entitled “FY16 At-Sea Test of Railgun” in Navy briefing entitled “Railgun Program Overview,” undated but posted at InsideDefense.com on April 14, 2015. (InsideDefense.com states that the briefing was presented at a public conference on April 14, 2015.)

In January 2015, it was reported that the Navy is projecting that EMRG could become operational on a Navy ship between 2020 and 2025.³⁹ In April 2015, it was reported that the Navy is considering installing an EMRG on a Zumwalt (DDG-1000) class destroyer by the mid-2020s.⁴⁰

³⁶ The Navy states that “a megajoule is a measurement of energy associated with a mass traveling at a certain velocity. In simple terms, a one-ton vehicle moving at 100 mph equals a magajoule of energy.” (Office of Naval Research Public Affairs, “Navy Sets New World Record with Electromagnetic Railgun Demonstration,” *Navy News Service*, December 10, 2010, accessed August 12, 2015, at http://www.navy.mil/submit/display.asp?story_id=57690.)

³⁷ Grace Jean, “With a Bang, Navy Begins Tests on EM Railgun Prototype Launcher,” *Navy News Service*, February 28, 2012, accessed August 12, 2015, at http://www.navy.mil/submit/display.asp?story_id=65577.

³⁸ Naval Sea Systems Command Office of Corporate Communication, “Navy to Deploy Electromagnetic Railgun Aboard JHSV,” *Navy News Service*, April 7, 2014, accessed August 12, 2015, at http://www.navy.mil/submit/display.asp?story_id=80055.

In January 2015, it was reported that the Navy is projecting that EMRG could become operational on a Navy ship between 2020 and 2025.⁴¹ In April 2015, it was reported that the Navy is considering installing an EMRG on a Zumwalt (DDG-1000) class destroyer by the mid-2020s.⁴²

HVP

Overview

As the Navy was developing EMRG, it realized that the guided projectile being developed for EMRG could also be fired from 5-inch and 155mm powder guns. Navy cruisers each have two 5-inch guns, and Navy Arleigh Burke (DDG-51) class destroyers each have one 5-inch gun. The Navy's three new Zumwalt class (DDG-1000) destroyers, the first of which entered service in October 2016, each have two 155mm guns.

The projectile, which weighs about 23 pounds,⁴³ is a hypervelocity projectile when fired from either EMRG or a powder gun, but the term HVP tends to be used more frequently in connection with the concept of firing it from a powder gun. The Navy described HVP in September 2012 as

is a next generation, common, low drag, guided projectile capable of completing multiple missions for gun systems such as the Navy 5-Inch, 155-mm, and future railguns. Types of missions performed will depend on gun system and platform. The program goal is to address mission requirements in the areas of Naval Surface Fire Support, Cruise Missile

(...continued)

³⁹ Sam LaGrone, "Navy Wants Rail Guns to Fight Ballistic and Supersonic Missiles Says RFI," *USNI News*, January 5, 2015.

⁴⁰ Sam LaGrone, "Navy Considering Railgun for Third Zumwalt Destroyer," *USNI News*, February 5, 2015 (updated February 11, 2015); Mike McCarthy, "Navy Aiming To Put Railgun On Third Zumwalt Destroyer," *Defense Daily*, February 6, 2015; Kris Osborn, "Navy Will Test its Electromagnetic Rail Gun aboard DDG 1000," *DefenseTech*, April 15, 2015. For more on Zumwalt-class destroyers, see CRS Report RL32109, *Navy DDG-51 and DDG-1000 Destroyer Programs: Background and Issues for Congress*, by Ronald O'Rourke.

⁴¹ Sam LaGrone, "Navy Wants Rail Guns to Fight Ballistic and Supersonic Missiles Says RFI," *USNI News*, January 5, 2015.

⁴² Sam LaGrone, "Navy Considering Railgun for Third Zumwalt Destroyer," *USNI News*, February 5, 2015 (updated February 11, 2015); Mike McCarthy, "Navy Aiming To Put Railgun On Third Zumwalt Destroyer," *Defense Daily*, February 6, 2015; Kris Osborn, "Navy Will Test its Electromagnetic Rail Gun aboard DDG 1000," *DefenseTech*, April 15, 2015. For more on Zumwalt-class destroyers, see CRS Report RL32109, *Navy DDG-51 and DDG-1000 Destroyer Programs: Background and Issues for Congress*, by Ronald O'Rourke.

⁴³ The Navy states that HVP weighs 23 pounds. Source: David Martin, "Navy's Newest Weapon Kills at Seven Times the Speed of Sound," *CBS News (cbssnews.com)*, April 7, 2014.

BAE Systems states that HVP is 24 inches long and weighs 28 pounds, including a 15-pound payload. The total length and weight of an HVP launch package, BAE Systems states, is 26 inches and 40 pounds. BAE states that the maximum rate of fire for HVP is 20 rounds per minute from a Mk 45 5-inch gun, 10 rounds per minute from the 155mm gun on DDG-1000 class destroyers (called the Advanced Gun System, or AGS), and 6 rounds per minute from EMRG. HVP's firing range, BAE Systems states, is more than 40 nautical miles (when fired from a Mk 45 Mod 2 5-inch gun), more than 50 nautical miles (Mk 45 Mod 4 5-inch gun), more than 70 nautical miles (155mm gun on DDG-1000 class destroyers), and more than 100 nautical miles (EMRG). (BAE Systems, "Hypervelocity Projectile (HVP)," 2014, accessed August 14, 2015, at http://www.baesystems.com/download/BAES_178505/hyper-velocity-projectile-hvp-datasheet.)

In July 2015, the Navy issued a request for information (RFI) to industry for the fabrication of a prototype EMRG mount capable of handling an integrated launch weight package of 22 kg, or about 48.5 pounds. (RFI for Fabrication of Prototype Mount for Naval Railgun, Solicitation Number: N00024-15-R-4132, FedBizOpps.gov, July 29, 2015. See also Justin Doubleday, "Navy Developing Integrated Mount For Electromagnetic Railgun," *Inside the Navy*, July 31, 2015.)

Defense, Anti-Surface Warfare, and other future Naval mission areas. Mission performance will vary from gun system, launcher, or ship. HVP's low drag aerodynamic design enables high velocity, maneuverability, and decreased time-to-target. These attributes coupled with accurate guidance electronics provide low cost mission effectiveness against current threats and the ability to adapt to air and surface threats of the future.

The high velocity compact design relieves the need for a rocket motor to extend gun range. Firing smaller more accurate rounds improves danger close/collateral damage requirements and provides potential for deeper magazines and improved shipboard safety. Responsive wide area coverage can be achieved using HVP from conventional gun systems and future railgun systems.

The modular design will allow HVP to be configured for multiple gun systems and to address different missions. The hypervelocity projectile is being designed to provide lethality and performance enhancements to current and future gun systems. A hypervelocity projectile for multiple systems will allow for future technology growth while reducing development, production, and total ownership costs.

Research Challenges & Opportunities [include]:

- High acceleration tolerant electronic components
- Lightweight, high strength structural composites
- Miniature, high density electronic components
- Safe high energy propellants compatible with shipboard operations
- Aerothermal protection systems for flight vehicles⁴⁴

Figure 10 and **Figure 11** show the HVP.

When fired from 5-inch powder guns, the projectile achieves a speed of roughly Mach 3, which is roughly half the speed it achieves when fired from EMRG, but more than twice the speed of a conventional 5-inch shell fired from a 5-inch gun.⁴⁵ This is apparently fast enough for countering at least some ASCMs. The Navy states that “The HVP—combined with the MK 45 [5-inch gun]⁴⁶—will support various mission areas including naval surface fire support, and has the capacity to expand to a variety of anti-air threats, [and] anti-surface [missions], and could expand the Navy's engagement options against current and emerging threats.”⁴⁷

A December 21, 2016, opinion column states:

Now the Navy is acquiring rail guns that use such energy to fire 15- to 25-pound, 18-inch projectiles at 5,000 miles per hour. They hit with the impact of a train slamming into a wall at 100 miles per hour. The high-speed, hence high-energy projectiles, which cost just \$25,000, can radically improve fleet-protection capabilities: A barrage of them could counter an enemy's more expensive anti-ship missiles.

⁴⁴ Office of Naval Research, “Hypervelocity Projectile,” September 2012, accessed October 21, 2016, at <http://www.onr.navy.mil/~media/Files/Fact-Sheets/35/Hypervelocity-Projectile-2012B.ashx>.

⁴⁵ Source: Sam LaGrone, “Updated: Navy Researching Firing Mach 3 Guided Round from Standard Deck Guns,” *USNI News*, June 1, 2015 (updated June 2, 2015).

⁴⁶ The type of 5-inch gun on Navy cruisers and destroyers is called the Mark 45.

⁴⁷ Naval Surface Warfare Center Dahlgren Division Corporate Communications, “DEPSECDEF Loads HVP on Test Range, Observes Repetitive Rate Electromagnetic Railgun's Commissioning Series,” *Navy News Service*, May 8, 2015, accessed August 12, 2015, at http://www.navy.mil/submit/display.asp?story_id=86987.

The daunting challenge posed by defense against the proliferating threat of ballistic missiles is that it is prohibitively expensive to be prepared to intercept a swarm of incoming missiles. New technologies, however, can revolutionize defense against ballistic missiles because small, smart projectiles can be inexpensive. It takes 300 seconds to pick up such a launched missile's signature, the missile must be tracked and a vector calculated for defensive projectiles. A single 25-pound projectile can dispense more than 500 three-gram tungsten impactors and be fired at hypervelocity by electromagnetic energy. Their impact force—their mass times the square of their velocity—can destroy expensive missiles and multiple warheads.⁴⁸

Figure 10. Photograph Showing HVP



Source: Navy photograph dated April 4, 2014, with a caption that reads in part: “Rear Adm. Matthew Klunder, chief of naval research, shows off a Hypervelocity Projectile (HVP) to CBS News reporter David Martin during an interview held at the Naval Research Laboratory's materials testing facility.” Accessed August 12, 2015, at http://www.navy.mil/view_image.asp?id=174517.

One advantage of the HVP/5-inch gun concept is that the 5-inch guns are already installed on Navy cruisers and destroyers, creating a potential for rapidly proliferating HVP through the cruiser-destroyer force, once development of HVP is complete and the weapon has been integrated into cruiser and destroyer combat systems.

⁴⁸ George F. Will, “Can Mattis Make Peace Through Technology?” *Washington Post*, December 21, 2016.

Figure 11. HVP

NAVSEA
NAVAL SEA SYSTEMS COMMAND

U.S. NAVAL RESEARCH LABORATORY

Multi-Mission HVP

Hyper Velocity Projectile

Missions

- Anti-Air
- NSFS Strike
- Missiles
- Anti-Surface

Technologies

- High-G Electronics
- Packaging
- Miniaturization
- Thermal Protect
- Adv. Energetics

Weapon Systems

- 5-Inch Mk 45
- Railgun
- 155 mm - AGS
- 155 mm

- High speed launch enables effectiveness
- High density electronics enables packaging & survivability
- High computational power enables advanced tracking & guidance algorithms

Distribution A Slide 7 6/3/2014

Source: Slide 7 from Navy briefing entitled “Electromagnetic Railgun,” NDIA Joint Armaments Forum, Exhibition & Technology Demonstration, May 14, 2014, LCDR Jason Fox, USN, Assistant PM [Program Manager], Railgun Ship Integration, Distribution A, Approved for Public Release, accessed August 13, 2015, at <http://www.dtic.mil/ndia/2014armaments/WedFox.pdf>.

Figure 12 shows HVP launch packages configured for 5-inch guns, 155mm guns, and EMRG.

Figure 12. HVP Launch Packages

Launch packages for 5-inch gun, 155mm gun, and EMRG

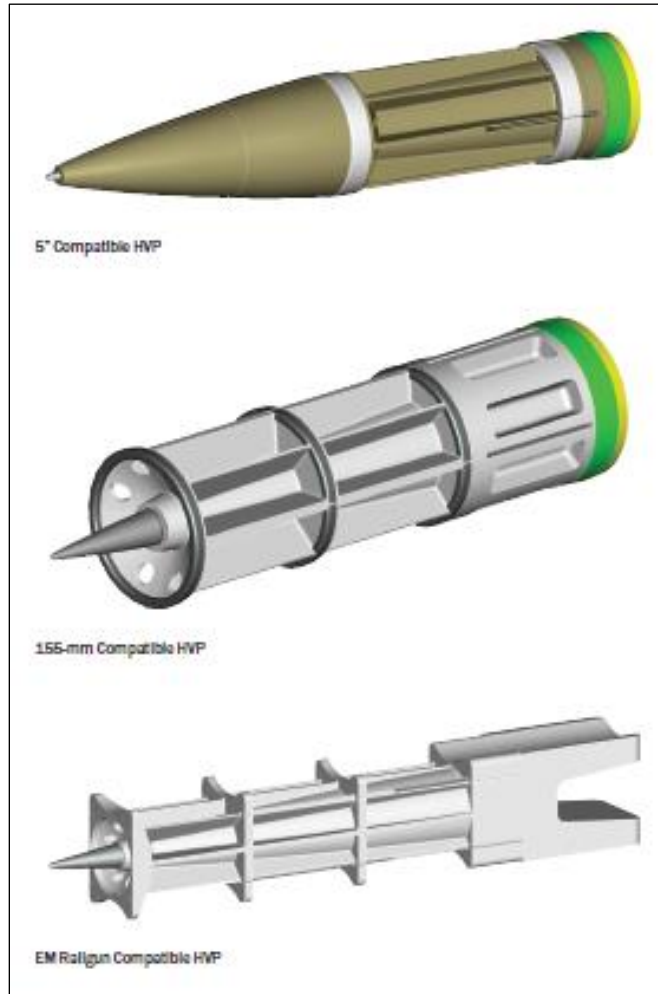



Source: BAE Systems, "Hypervelocity Projectile (HVP)," 2014, accessed August 14, 2015, at http://www.baesystems.com/download/BAES_178505/hyper-velocity-projectile--datasheet.

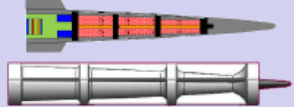

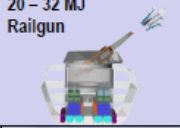







Figure 13 is a slide showing the potential application of HVP to 5-inch power guns, 155mm powder guns, and EMRG. The first line of the slide, for example, discusses HVP's use with 5-inch powder guns, stating that it uses a high-explosive (HE) warhead for the NSFS mission;⁴⁹ that a total of 113 5-inch gun barrels are available in the fleet (which could be a reference to 22 cruisers with two guns each, and 69 destroyers with one gun each); and that as a game-changing capability, it is guided and can be used at ranges of up to 26 nautical miles to 41 nautical miles for NSFS operations, for countering ASCMs, and for anti-surface warfare (ASuW) operations (i.e., attacking surface ships and craft).

⁴⁹ The "KE" in the next line down means that when fired from EMRG, the projectile can alternatively attack targets using its own kinetic energy (i.e., by impacting the target at hypersonic speed).

Figure 13. HVP Application to Various Launchers

Commonality Approach

| GUN SYSTEM | PROJECTILE (SABOTED & SUB-CALIBER) | MISSION & WARHEAD TYPE | TRANSITION OPPORTUNITIES | GAME CHANGING CAPABILITY |
|---|---|------------------------|----------------------------------|--|
|  5" MK 45 MOD 2/4 |   | NSFS - HE | 113 Barrels (PEO IWS) | GUIDED 26 - 41 NM NSFS/ASCM/ASuW |
|  20 - 32 MJ Railgun |   | NSFS - HE NSFS - KE | FUTURE (PMS405/PEO IWS) | GUIDED 50 - 100 NM NSFS/ASCM/ASuW/ Future Threats |
|  155 mm - AGS |   | NSFS - HE | 6 Barrels (PEO IWS) | GUIDED 40 NM NSFS/ASCM/ASuW |
|  155 mm |   | Ground Fires - HE | 800 ARMY 300 MARINE ASSETS | GUIDED 17 NM Fires/CMD |

Multi-Barrel, Multi-Mission, & Multi-Service Applications

Distribution A Slide 16 6/3/2014

Source: Slide 16 from Navy briefing entitled "Electromagnetic Railgun," NDIA Joint Armaments Forum, Exhibition & Technology Demonstration, May 14, 2014, LCDR Jason Fox, USN, Assistant PM [Program Manager], Railgun Ship Integration, Distribution A, Approved for Public Release, accessed August 13, 2015, at <http://www.dtic.mil/ndia/2014armaments/WedFox.pdf>.

Figure 14 is a not-to-scale illustration of how HVPs fired from EMRGs and 5-inch guns can be used to counter various targets, including ASCMs and ASBMs.

Figure 14. Navy Slide Depicting Operations Against Various Target Types

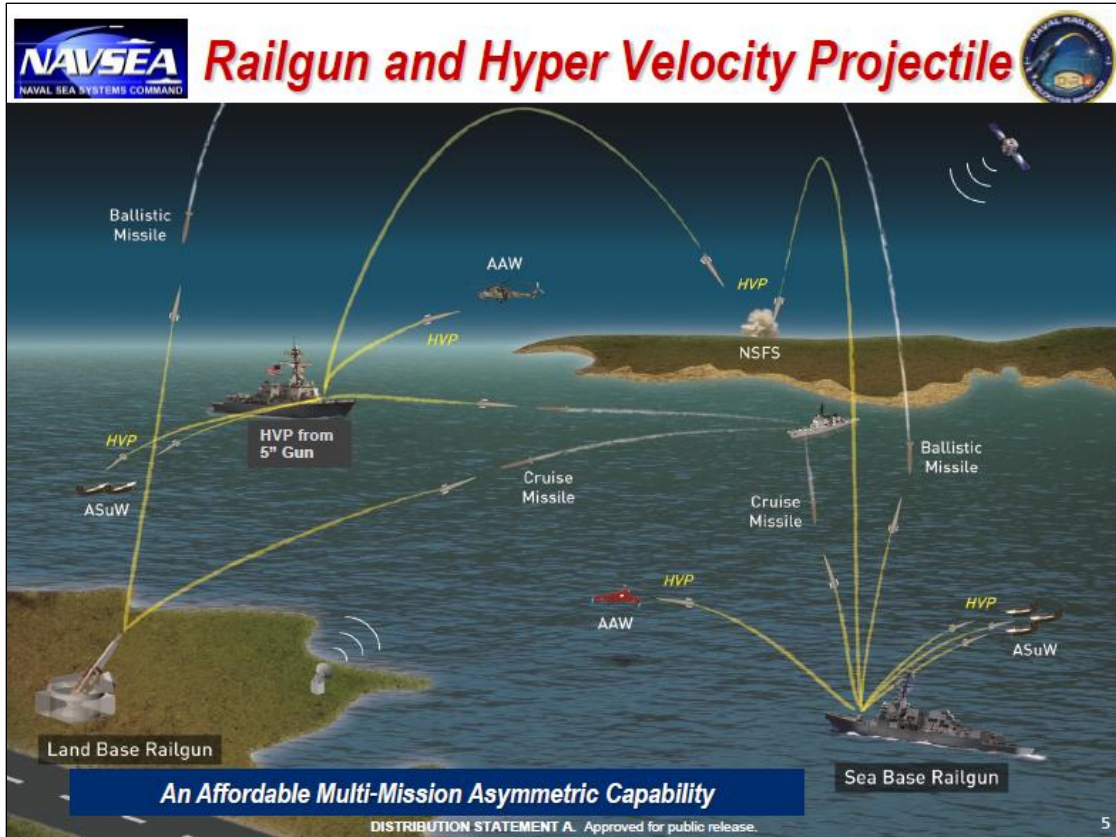

Source: Slide 5 from Navy briefing entitled "Electromagnetic Railgun," NDIA Joint Armaments Forum, Exhibition & Technology Demonstration, May 14, 2014, LCDR Jason Fox, USN, Assistant PM [Program Manager], Railgun Ship Integration, Distribution A, Approved for Public Release, accessed August 13, 2015, at <http://www.dtic.mil/ndia/2014armaments/WedFox.pdf>.

DOD Interest in HVP

The HPV has emerged as a program of particular interest to DOD, which is exploring the potential for using the weapon across multiple U.S. military services. An April 11, 2016, press report states:

The Pentagon wants to take a weapon originally designed for offense, flip its punch for defense and demonstrate by 2018 the potential for the Army and Navy to conduct missile defense of bases, ports and ships using traditional field guns to fire a new hypervelocity round guided by a mobile, ground variant of an Air Force fighter aircraft radar.

The Strategic Capabilities Office is working with the Army, Navy and Air Force to craft a Hypervelocity Gun Weapon System that aims, in part, to provide China and Russia an example of a secret collection of new U.S. military capabilities the Defense Department is bringing online in an effort to strengthen conventional deterrence.

"It is a fantastic program," Will Roper, Strategic Capabilities Office director, said in a March 28 interview with reporters, who said the project aims "to completely lower the

cost of doing missile defense" by defeating missile raids at a lower cost per round and, as a consequence, imposing higher costs on attackers.⁵⁰

A May 2, 2016, press report states:

"We thought rail guns were something we were really going to go after, but it turns out that powder guns firing the same hypervelocity projectiles gets you almost as much as you would get out of the electromagnetic rail gun, but it's something we can do much faster," [Deputy Secretary of Defense Robert] Work said. "We are going to say [to the next administration] 'Look, we believe this is the place where you want to put your money, but we're going to have enough money in there for both the electromagnetic rail gun and the powder gun.' So if the new administration says 'No really the electromagnetic rail gun is the way I want to go,' knock yourself out, we've set you up for success."⁵¹

A May 5, 2016, press report similarly states:

Come January [2017], the Pentagon will almost assuredly have new leadership, complete with a new vision for how the Department of Defense should operate, organize and plan for the future.

It's a reality facing down Defense Secretary Ash Carter and Deputy Secretary Bob Work as they try to complete a transformation at the Pentagon, one which both men have said is vital to making sure the US is able to maintain its technological edge against great powers like Russia and China in the future....

"One of the things we have done in our program is build in a lot of different options that they [i.e., officials in the next administration] can pull levers on," Work explained.

As an example, he pointed to the idea of an electromagnetic railgun. Initially, Work and his team thought that was an area that would be a major focus of development, but as they experimented they realized that a powder gun with a hypervelocity round could have almost the same impact—but at a fraction of the cost, because it did not require the development, testing and adaptation of a new gun.

"We're going to say 'look, this is the place where [we think] you want to put your money,' but we're going to have enough money in both the electromagnetic railgun and the powder gun that if the new administration says 'I really want the electromagnetic railgun, this is the way I want to go,' knock yourself out," Work said. "We've set you up for success."⁵²

A May 9, 2016, press report states:

Deputy Defense Secretary Bob Work said last week that current Pentagon leaders have made investments intended to position the next presidential administration to offset expected Russian and Chinese technological advancements, specifically highlighting lessons learned about a new hypervelocity gun.

Work... said one of the key findings to emerge from the effort was the Hypervelocity Gun Weapon System, which he said could be poised to displace much of what the Defense Department had planned to invest in the Navy's electromagnetic rail gun.

⁵⁰ Jason Sherman, "SCO Aims To Flip The Script on Missile Defense With Hypervelocity Gun," *Inside the Navy*, April 11, 2016.

⁵¹ Scott Maucione, "DoD Is Setting Up the Third Offset for the Next President," *Federal News Radio*, May 2, 2016.

⁵² Aaron Mehta, "Pentagon No. 2: How to Keep Third Offset Going in the Next Administration," *Defense News*, May 5, 2016.

"We thought rail guns we're going to be something we were really going to go after," he said, adding that "it turns out that powder guns" are capable of firing the same projectiles, at the same velocity, for far less cost.⁵³

A July 18, 2016, press report states:

The Pentagon's office tasked with tweaking existing and developing military technology for new uses is pushing development of ammo meant for the electromagnetic railgun for use in existing naval guns and artillery pieces....

About year and a half ago, researchers at the Pentagon's Strategic Capabilities Office and inside the service realized that there was more short-term promise for not only the Navy but the Army to use the Hyper Velocity Projectiles (HVP) rounds overseen by the Office of Naval Research (ONR) in both services existing powder guns, said SCO [Strategic Capabilities Office] head William Roper said last week.

"To me they were just interesting test articles a few years ago, but thanks to that service input and us funding some high-risk demonstration we now think that we can do pretty revolutionary things with existing powder guns—think howitzers, Paladins, the Navy's five-inch guns. We've shifted emphasis to that," Roper said during a Wednesday talk at the Center for Strategic and International Studies (CSIS).

"Not that we're not interested in railgun—we are—but if you look at the delta between fielding in quantity—we have [more than] a 1,000 powder guns, we have very few railguns."...

The SCO-led research effort will work to create HVP sensor and a fire control regime that will find its way eventually to the railgun project, Roper said.

"So when the railgun is ready to field it will be able to just be dropped in place as a better launcher as opposed to being a great technology that we have to build a new architecture for," he said.

"We're going to take the bet and let's see if we can field this and let's completely flip the paradigm of missile defense."⁵⁴

A September 19, 2016, press report states:

After much deliberation, both public and private, the Pentagon, which has shifted emphasis away from the electromagnetic rail gun as a next-generation missile defense platform, sees a new hypervelocity powder gun technology as the key to demonstrating to potential adversaries like China and Russia that U.S. military units on land and sea can neutralize large missile salvos in future conflicts....

"If you do that, you change every 155 [mm] howitzer in the U.S. Army in every NATO country into a cruise missile and tactical ballistic missile defender and, oh by the way, you extend their offensive range," [Deputy Secretary of Defense Robert] Work said.

The article states that Work "is pushing hard to lay the groundwork for the next presidential administration to conduct a military exercise called 'Raid Breaker' that would demonstrate the capabilities of the Hypervelocity Gun Weapon System program." It quotes him as stating that if DOD conducted such an exercise against 100 cruise missiles and ballistic missiles, "and were able to convince [potential adversaries] that we're able to knock down 95 to 98 of them, then that

⁵³ Tony Bertuca, "Work: New Hypervelocity Gun Could Displace Rail Gun in Next Administration," *Inside the Navy*, May 9, 2016.

⁵⁴ Sam LaGrone, "Pentagon: New Rounds For Old Guns Could Change Missile Defense for Navy, Army," *USNI News*, July 16, 2016 (updated July 19, 2016).

would have an enormous impact on the competition in the Pacific, on the competition in Europe and would [clearly] improve conventional deterrence.” It further quotes him as stating that DOD’s modeling shows that “if we can close the fire support with a controlled solution,” the weapon would be able to shoot down most of a 100-missile raid.⁵⁵

Indirectly Improving Ability to Counter ASCMs and ASBMs

As discussed earlier, SSLs currently under development have enough beam power to counter small boats and UAVs, but not enough to counter ASCMs or ASBMs. Even so, such SSLs could indirectly improve a ship’s ability to counter ASCMs and ASBMs by permitting the ship to use fewer of its SAMs for countering UAVs, and more of them for countering ASCMs and ASBMs. Similarly, even though HVPs fired from 5-inch powder guns might not be able to counter ASBMs, they could indirectly improve a ship’s ability to counter ASBMs by permitting the ship to use fewer of its SAMs for countering ASCMs and more of its SAMs for countering ASBMs.

Remaining Development Challenges

Although the Navy in recent years has made considerable progress in developing SSLs, EMRG, and HVP, a number of significant development challenges remain. Overcoming these challenges will likely require years of additional development work, and ultimate success in overcoming them is not guaranteed.⁵⁶

SSLs

As shown in **Figure 15**, remaining development challenges for SSLs include, among other things, making the system rugged enough for extended shipboard use, making the beam director (the telescope-like part of the laser that sends the beam toward the target) suitable for use in a marine environment (where moisture and salt in the air can be harsh on equipment), and integrating the system into the ship’s electrical power system and combat system.

A January 23, 2015, blog post co-authored by the Office of Naval Research’s program officer for the Navy’s SSL program states:

In the near term, many challenges remain to develop and operate high-energy laser systems in the maritime environment that are unique to the Navy and Marine Corps. Among these challenges is dealing with the heat generated as power levels increase. A second issue is packing sufficient power on the platform, which will require advanced battery, generator, power conditioning, and hybrid energy technologies. Current laser technologies are approximately 30 percent electrically efficient. Corrosion and contamination of optical windows by shipboard salt spray, dirt, and grime also are technical challenges. In addition, atmospheric turbulence resulting from shifting weather

⁵⁵ Tony Bertuca, “DOD’s New Hypervelocity Gun Technology Emerging As Key BMD Capability,” *Inside the Navy*, September 19, 2016.

⁵⁶ Laser skeptics sometimes note that laser proponents over the years have made numerous predictions about when lasers might enter service with DOD, and that these predictions repeatedly have not come to pass. Viewing this record of unfulfilled predictions, skeptics might argue that “lasers are X years in the future—and always will be.” Laser proponents acknowledge the record of past unfulfilled predictions, but argue that the situation has now changed because of rapid advancements in SSL technology and a shift from earlier ambitious goals (such as developing megawatt-power lasers for countering targets at tens or hundreds of miles) to more realistic goals (such as developing kilowatt-power lasers for countering targets at no more than a few miles). Laser proponents might argue that laser skeptics are vulnerable to what might be called cold plate syndrome (i.e., a cat that sits on a hot plate will not sit on a hot plate again—but it will not sit on a cold plate, either).

conditions, moisture, and dust is problematic. Turbulence can cause the air over long distances to act like a lens, resulting in the laser beam's diffusing and distorting, which degrades its performance.

Much progress has been made in demonstrating high-energy laser weapon systems in the maritime environment, but there is still much to be done. Additional advances will be required to scale power levels to the hundreds of kilowatts that will make high[-]energy lasers systems robust, reliable, and affordable. Higher power levels are important for the ability to engage more challenging threats and improve the rate and range at which targets can be engaged.

The programs managed by ONR are addressing these remaining issues while positioning this important warfighting capability toward an acquisition program and eventual deployment with the fleet and force.⁵⁷

Figure 15. Development Challenges for SSLs

As of February 2013



Source: Slide from Navy briefing entitled “Navy Solid State Laser Program Overview,” ASNE Day 2013, Mr. Peter “Rollie” Morrison, ONR 35 S&T Program Office, February 22, 2013, accessed August 13, 2015, at https://www.navalengineers.org/ProceedingsDocs/ASNEday2013/Morrison_Pres.pdf.

⁵⁷ Peter Morrison and Dennis Sorenson, “Developing a High-Energy Laser for the Navy,” *Future Force*, January 23, 2015, accessed August 13, 2015, at <http://futureforce.navylive.dodlive.mil/2015/01/high-energy-laser/>. The authors are identified at the end of the post as follows: “Peter Morrison is the Office of Naval Research’s program officer for the Navy’s Solid-State Laser program. Dennis Sorenson is a contractor with the Office of Naval Research.”

EMRG and HVP

As shown in **Figure 16**, remaining development challenges for EMRG involve items relating to the gun itself (including increasing barrel life to desired levels), the projectile, the weapon's electrical power system, and the weapon's integration with the ship. Fielding HVP on cruisers and destroyers ships equipped with 5-inch and 155mm powder guns would additionally require HVP to be integrated with the combat systems of those ships.

Figure 16. Development Challenges for EMRG

As of May 2014



Naval Railgun – Focus of Effort

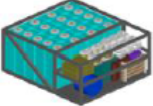

| | |
|--|---|
| <h3 style="text-align: center; color: blue;">Launcher</h3>  <ul style="list-style-type: none"> Multi-shot barrel life Barrel construction to contain rail repulsive forces Scaling from 8MJ (state of the art) to 32MJ Thermal management techniques M&S – Represent interaction between bore and projectile | <h3 style="text-align: center; color: blue;">Projectile</h3>  <ul style="list-style-type: none"> Dispensing and Unitary Rounds Gun launch survivability <ul style="list-style-type: none"> – 20 to 45 kG acceleration – Aero Thermal Risk Management Hypersonic guided flight for accuracy Lethality mechanics |
| <h3 style="text-align: center; color: blue;">Power & Energy</h3> <div style="display: flex; justify-content: space-around;"> <div style="text-align: center;">  <p>Pulsed Power Capacitors</p> <ul style="list-style-type: none"> Energy Density Rep rate operation & thermal management Switching </div> <div style="text-align: center;">  <p>Batteries</p> </div> </div> | <h3 style="text-align: center; color: blue;">Ship Integration</h3>  <ul style="list-style-type: none"> Dynamic Power Sharing Space and Weight Cooling EM Field Management |

Distribution A
Slide 9
6/3/2014

Source: Slide 9 from Navy briefing entitled “Electromagnetic Railgun,” NDIA Joint Armaments Forum, Exhibition & Technology Demonstration, May 14, 2014, LCDR Jason Fox, USN, Assistant PM [Program Manager], Railgun Ship Integration, Distribution A, Approved for Public Release, accessed August 13, 2015, at <http://www.dtic.mil/ndia/2014armaments/WedFox.pdf>.

The Navy states:

The EMRG effort began in FY 2005 with a focus on the barrel, power storage, and rail technology. In 2015, the Navy is testing full-scale industry advanced composite launchers for structure strength and manufacturability, and has advanced the pulsed-power system design from single-shot to actively cooled repeated rate operations. Building on the success of the first phase, the second phase started in 2012 with a focus on developing equipment and techniques to fire ten rounds per minute. Thermal-management techniques required for sustained firing rates are in development for both the launcher system and the pulsed-power system. The Office of Naval Research will develop a tactical prototype

EMRG launcher and pulsed-power architecture suitable for advanced testing both afloat and ashore. Railgun demonstration has been funded to occur in FY 2016.⁵⁸

A June 2015 press report states:

As the Navy prepares to test its electromagnetic railgun at sea for the first time in 2016, service leaders said one of the biggest challenges will be integrating the new technology onto existing platforms.....

[Vice Adm. William Hilarides, commander of Naval Sea Systems Command] said he is positive the Navy will successfully demonstrate the weapon's ability to fire from the Trenton, but one of the biggest challenges will be configuring the railgun so that it fits within the power structure of other existing platforms.

"Those are not 600-ton margin ships," he said [meaning ships with 600 tons of growth margin available to accommodate EMRG]. "If they have 60 tons, if they have 16 tons, then we'll be talking about what do we take off our existing destroyers, cruisers and other ships in order to get this incredible capability [on them]."

These types of discussions are influencing ship designs as program managers look at what systems are indispensable and what can be exchanged, Hilarides said.

Integrating the railgun into the fleet won't be a swift process.

It will be at least 10 years until the railgun is fielded on new ships and potentially 30 years past that before the Navy considers removing powder guns from the fleet entirely and transitioning to energy weapons alone, according to Hilarides.⁵⁹

Issues for Congress

Potential Oversight Questions

Potential oversight questions for Congress regarding Navy programs for SSLs, EMRG, and HVP include the following:

- Using currently available approaches for countering ASCMs and ASBMs, how well could Navy surface ships defend themselves in a combat scenario against an adversary such as China that has large numbers of ASCMs (including advanced models) and ASBMs? How would this change if Navy surface ships in coming years were equipped with SSLs, EMRG, HVP, or some combination of these systems?
- How significant are the remaining development challenges for SSLs, EMRG, and HVP?
- Are current schedules for developing SSLs, EMRG, and HVP appropriate in relation to remaining development challenges and projected improvements in enemy ASCMs and ASBMs? To what degree are current schedules for developing SSLs, EMRG, or HVP sensitive to annual funding levels?

⁵⁸ U.S. Navy, *U.S. Navy Program Guide 2015*, p. 169.

⁵⁹ Allyson Versprille, "Integration Biggest Challenge for Railgun," *National Defense*, June 2015. See also Lance M. Bacon, "3-Star: 'Lot of Work' Before Railgun Arrives in Fleet," *Navy Times*, February 5, 2015.

- When does the Navy anticipate issuing roadmaps detailing its plans for procuring and installing production versions of SSLs, EMRGs, and HVP on specific Navy ships by specific dates?
- Will the kinds of surface ships that the Navy plans to procure in coming years have sufficient space, weight, electrical power, and cooling capability to take full advantage of SSLs (particularly those with beam powers above 200 kW) and EMRG? What changes, if any, would need to be made in Navy plans for procuring large surface combatants (i.e., destroyers and cruisers) or other Navy ships to take full advantage of SSLs and EMRG?
- Are the funding sources for SSLs, EMRG, and HVP in Navy and Defense-Wide research and development accounts (see “Summary of Congressional Action on FY2017 Funding” below) sufficiently visible for supporting congressional oversight?

Legislative Activity for FY2017

Summary of Congressional Action on FY2017 Funding

Funding in the defense budget for research and development work on Navy SSLs, EMRG, and HVP is spread across several research and development account line items (which are known as program elements, or PEs). The PEs shown in **Table 1** capture much but not necessarily all of the funding for developing Navy SSLs, EMRG, and HVP. Moreover, the PEs shown in the table (particularly the final line in the table, showing the PE for Advanced Innovative Technology), include funding for efforts other than Navy SSLs, EMRG, and HVP, so congressional changes from requested amounts might or might not relate to SSLs, EMRG, or HVP.

Table 1. Summary of Congressional Action on FY17 Funding

In millions of dollars, rounded to nearest tenth

| Program Element (PE) number, PE name, FY16 budget line number | Req. | Authorization | | | Appropriation | | | |
|--|-------|---------------|-------|-------|------------------------|-------------------|-------|-------|
| | | HASC | SASC | Conf. | HAC (committee report) | House (as passed) | SAC | Conf. |
| 0602114N , Power Projection Applied Research, line 4 | 41.4 | 41.4 | 41.4 | 41.4 | 41.4 | 41.4 | 61.4 | 61.4 |
| 0602750N , Future Naval Capabilities Applied Research, line 13 | 165.1 | 165.1 | 165.1 | 165.1 | 157.1 | 157.1 | 165.1 | 157.1 |
| 0603114N , Power Projection Advanced Technology, line 16 | 96.4 | 106.4 | 81.4 | 96.4 | 76.6 | 106.4 | 96.4 | 96.4 |
| 0603673N , Future Naval Capabilities Advanced Technology Development, line 21 | 249.1 | 249.1 | 239.1 | 247.1 | 252.1 | 252.1 | 259.1 | 266.1 |
| 0603925N , Directed Energy and Electric Weapon System, line 75 | 32.7 | 32.7 | 32.7 | 32.7 | 32.7 | 32.7 | 32.7 | 32.7 |
| 0604250D8Z , Advanced Innovative Technology, line 95 | 844.9 | 804.9 | 844.9 | 829.9 | 844.9 | 844.9 | 829.9 | 834.9 |

Source: Table prepared by CRS based on Navy FY17 budget submission, committee reports, House floor consideration of H.R. 5293, authorization conference report, and appropriations conference explanatory statement.

Notes: **HASC** is House Armed Services Committee; **SASC** is Senate Armed Services Committee; **HAC** is House Appropriations Committee; **SAC** is Senate Appropriations Committee; **Conf.** is conference agreement. The PEs shown in the table below capture much but not necessarily all of the funding for work on Navy SSLs, EMRG, and HVP. The PEs shown in the table, moreover, include funding for efforts other than Navy SSLs, EMRG, and HVP.

FY2017 National Defense Authorization Act (H.R. 4909/S. 2943/P.L. 114-328)

House

The House Armed Services Committee, in its report (H.Rept. 114-537 of May 4, 2016) on H.R. 4909 of the 114th Congress, recommended the funding levels shown in the HASC column of **Table 1**. The recommended increase of \$10 million for PE 0603114N, Power Projection Advanced Technology (line 16) is for “Program increase for common mount.” (Page 498) The recommended reduction of \$40 million for PE 0604250D8Z, Advanced Innovative Technology (line 95) is for “SCO” (the Strategic Capabilities Office). (Page 518) H.Rept. 114-537 states:

Common mount for electromagnetic railgun

The budget request contained \$96.4 million in PE 63114N for power projection advanced technology. Of this amount, \$15.4 million was included for the Navy’s electromagnetic railgun prototype.

The committee remains supportive of the Navy’s program for developing and deploying an electromagnetic railgun. The committee recognizes the growing imperative for the Navy to field this type of weapon, not only to increase capabilities for naval surface fire support and ballistic missile defense, but to also decrease the cost exchange model when comparing the railgun to conventional missiles or guns. However, the committee is increasingly concerned that the shift in emphasis to the hypervelocity projectile by the Strategic Capabilities Office has left the Navy with a funding gap in developing the requirements and design for a common mount, which is a necessary prerequisite to getting this capability into operational use. Therefore, the committee directs the Secretary of the Navy to provide a briefing to the House Committee on Armed Services by February 15, 2017, on the plan and milestone schedule for demonstrating and deploying a common railgun mount for sea- and land-based applications.

The committee recommends \$106.4 million, an increase of \$10.0 million, in PE 63114N to support the development of a common mount for the sea-based and land-based electromagnetic railgun. (Page 61)

H.Rept. 114-537 also states:

Strategic Capabilities Office

The budget request contained \$844.9 million in PE 64250D8Z for development activities of the Strategic Capabilities Office (SCO).

Created in 2012 by the Deputy Secretary of Defense, SCO has the mission to identify, analyze, demonstrate, and transition game-changing applications of existing and near-term technology to shape and counter emerging threats. SCO is comprised of a relatively small number of personnel and relies on other program office personnel and resources to execute its mission. The committee appreciates the nature of SCO’s mission and sustained leanness of the organization; however, the committee notes the budget for SCO

has grown exponentially each fiscal year. For example, the fiscal year 2017 budget request is nearly double the request for fiscal year 2016.

The committee is concerned that such rapid budget growth may bring with it some risks, including the demands on SCO's small staff, demands on other Department of Defense personnel, and impact of SCO decisions on existing programs. For example, the committee is aware of SCO's inclusion on the electromagnetic railgun development, and subsequent reprioritizing of its planned investment in that program for fiscal year 2017, resulting in a funding gap that could not be covered by the program office.

Additionally, the committee remains concerned that the transition of technologies from SCO has not been adequately captured and conveyed to the oversight committees. The report required by the committee report (H. Rept. 114-102) accompanying the National Defense Authorization Act for Fiscal Year 2016 has not been delivered and is now almost 6 months late. In order to support prudent use of taxpayer resources, and to ensure proper oversight of these activities, the committee believes this report should be provided and concerns addressed before supporting full funding of planned activities.

Therefore, the committee recommends \$804.9 million, a decrease of \$40.0 million, in PE 64250D8Z for development activities of the Strategic Capabilities Office. (Page 92)

Section 220 of H.R. 4909 as reported states:

SEC. 220. Designation of Department of Defense senior official with principal responsibility for directed energy weapons.

Not later than 180 days after the date of the enactment of this Act, the Secretary of Defense shall—

(1) designate a senior official already serving within the Department of Defense as the official with principal responsibility for the development and demonstration of directed energy weapons for the Department; and

(2) set forth the responsibilities of that senior official with respect to such programs.

H.Rept. 114-537 also states:

Five-inch precision guided projectile development for naval surface fire support

In the committee report (H. Rept. 114-102) accompanying the National Defense Authorization Act for Fiscal Year 2016, the committee noted “that current surface Navy gunnery requirements are outdated and that new technologies such as railgun and directed energy weapons are nearing readiness for technology transition.” The committee referenced the Advanced Naval Surface Fires (ANSF) initiative and noted the ANSF was assessing options for providing a near-term 5-inch guided munition capability. The committee understands this capability would provide for improved and extended-range naval surface fire support. The committee continues to support the need for this precision guided capability and is also aware of the Hypervelocity Gun Weapon System (HGWS) program that is currently under consideration by the Strategic Capabilities Office (SCO). The committee notes the HGWS program would “flip the cost equation using conventional guns to defend forward bases against raids of advanced cruise and ballistic missiles” and believes there could be applications for use in 5-inch gun systems for naval surface fires support. The committee is encouraged by the development of both of these initiatives and expects the Navy and SCO to coordinate on these capabilities. The committee also expects the Navy to proceed forward with an accelerated development and acquisition strategy for this needed capability that is consistent with acquisition reform principles. (Pages 62-63)

H.Rept. 114-537 also states:

Technology enablers for directed energy weapon systems

The committee is aware that the Department of Defense has made significant advances in the development and operational demonstration of directed energy weapons systems. Each military department has demonstrated a marquee program in this area, such as the Navy's Laser Weapon System deployed on the USS Ponce, the Army High Energy Laser Mobile Demonstrator, and the Marine Corps' Ground Based Air Defense System. Along with technology demonstration activities like the Robust Electric Laser Initiative and the High Energy Liquid Laser Area Defense System, each of these programs demonstrated the increased power output and power on target necessary to develop a militarily useful directed energy weapon.

However, as the Department has made progress in raising the power levels of these systems, it has also demonstrated the need for emphasis on development in other technology areas necessary to realize the full potential of laser weapons. For example, higher power output requires improved beam control to engage targets at greater distances, as well as better thermal management systems to dissipate the increased heat load. As the Department has been overcoming foundational technical challenges, new challenges have emerged that will impact the operational uses for directed energy weapons.

Therefore, the committee directs the Assistant Secretary of Defense for Research and Engineering, in coordination with the research components of the military departments and the High Energy Laser Joint Technology Office, to provide a briefing to the House Committee on Armed Services by January 20, 2017. This briefing should provide a roadmap for enabling technologies, including:

- (1) Beam directors and adaptive optics, including deformable mirrors;
- (2) Thermal management needs and capabilities;
- (3) Integration challenges with fire control systems, including potential future needs for fire control for laser systems;
- (4) Power architectures and power electronics needs;
- (5) Facilities and test range capabilities; and
- (6) Other areas as deemed by the Secretary. (Page 93)

Senate

The Senate Armed Services Committee, in its report (S.Rept. 114-255 of May 18, 2016) on S. 2943 of the 114th Congress, recommended the funding levels shown in the SASC column of **Table 1**. The recommended reduction of \$15 million to PE 0603114N, Power Projection Advanced Technology (line 16) is for "General decrease." (Page 481) The recommended reduction of \$10 million to PE 0603673N, Future Naval Capabilities Advanced Technology Development (line 21) is for "Capable manpower, and power and energy." (Page 481).⁶⁰ S.Rept. 114-255 states:

⁶⁰ This recommended reduction of \$10 million does not appear to relate (at least not directly) to lasers, the electromagnetic railgun, or the HVP. S.Rept. 114-255 states:

Capable manpower and power and energy

The budget request included \$249.1 million in PE 63673N for future naval capabilities advanced technology developments. The activities listed under this program element include capable manpower and power and energy. The committee believes that the work plans for fiscal year 2017 on these activities does not warrant the level of funding included in the budget request. For example, the committee notes that the research included in these two projects include development

(continued...)

Power projection advanced technology

The budget request included \$96.4 million in PE 63114N for power projection advanced technology. The committee notes that the Navy, Air Force, Defense Advanced Research Projects Agency, Strategic Capabilities Office, and other elements within the Department of Defense are all pursuing advanced power projection technologies and systems. The committee is concerned that these efforts are not well-coordinated and have uncertain pathways for transition to programs of record. In addition, the committee notes that the budget request represents an almost 200 percent increase over the amount enacted for fiscal year 2016. The committee believes that such a large increase in budget is not warranted and is concerned about the ability of the programs to absorb the additional funding. Consequently, the committee recommends a decrease of \$15.0 million in PE 63114N, but directs that this reduction not be assessed against solid state laser maturation efforts. (Page 52)

Section 216 of S. 2943 as reported states:

SEC. 216. Directed energy weapon system programs.

(a) Inclusion of Directed Energy Weapon System programs in the rapid acquisition authority program.—

(1) IN GENERAL.—Section 806(c)(1) of the Bob Stump National Defense Authorization Act for Fiscal Year 2003 (Public Law 107–314; 10 U.S.C. 2302 note) is amended by adding at the end the following new subparagraph:

“(D) (i) In the case of any supplies and associated support services that, as determined in writing by the Secretary of Defense without delegation, are urgently needed to eliminate a deficiency in directed energy weapon systems, the Secretary may use the procedures developed under this section in order to accomplish the rapid acquisition and deployment of needed offensive or defensive directed energy weapon systems capabilities, supplies, and associated support services.

“(ii) For the purposes of directed energy weapon systems acquisition, the Secretary of Defense shall consider use of the following procedures:

“(I) The rapid acquisition authority provided under this section.

“(II) Use of other transactions authority provided under section 2371 of title 10, United States Code.

“(III) The acquisition of commercial items using simplified acquisition procedures.

“(IV) The authority for procurement for experimental purposes provided under section 2373 of title 10, United States Code.

“(iii) In this subparagraph, the term ‘directed energy weapon systems’ means military action involving the use of directed energy to incapacitate, damage, or destroy enemy equipment, facilities, or personnel.”.

(2) CONFORMING AMENDMENTS.—Section 2373 of title 10, United States Code, is amended—

(...continued)

of new personnel and management methodologies, and capabilities in energy security. Both of these efforts could be better coordinated with other organizations performing similar research. Consequently, the committee recommends a decrease of \$10.0 million in PE 63673N to be distributed appropriately from capable manpower and power and energy. (Page 53)

(A) in subsection (a), by striking “and aeronautical supplies” and inserting “, aeronautical supplies, and directed energy weapon systems”; and

(B) by adding at the end of the following new subsection:

“(c) Directed energy weapon systems defined.—In this section, the term ‘directed energy weapon systems’ means military action involving the use of directed energy to incapacitate, damage, or destroy enemy equipment, facilities, or personnel.”.

(b) Joint Directed Energy Program Office.—

(1) REDESIGNATION.—The High Energy Laser Joint Technology Office of the Department of Defense is hereby redesignated as the “Joint Directed Energy Program Office” (in this subsection referred to as the “Office”).

(2) STRATEGIC PLAN FOR DEVELOPMENT AND FIELDING OF DIRECTED ENERGY WEAPONS CAPABILITIES.—In addition to the functions and duties of the Office in effect on the day before the date of the enactment of this Act, the Office shall develop a strategic plan for development and fielding of directed energy weapons capabilities for the Department, in which the Office may define requirements for directed energy capabilities that address the highest priority warfighting capability gaps of the Department.

(3) ACCELERATION OF DEVELOPMENT AND FIELDING OF DIRECTED ENERGY WEAPONS CAPABILITIES.—

(A) IN GENERAL.—To the degree practicable, the Office shall use the policies of the Department that are revised pursuant to this section and new acquisition and management practices established pursuant to this section to accelerate the development and fielding of directed energy capabilities.

(B) ENGAGEMENT.—The Secretary shall ensure that use of policies and practices described in subparagraph (A) include engagement with defense and private industries, research universities, and unaffiliated, nonprofit research institutions.

Regarding Section 216, S.Rept. 114-255 states:

Directed energy weapon system programs (sec. 216)

The committee remains concerned about the Department of Defense’s inability to field an operational directed energy system. The committee is aware that the military services and industry partners have developed sufficient directed energy weapon capabilities for specific scenarios—like the High Energy Laser Mobile Demonstrator (HEL–MD) to counter rocket, artillery and mortar for base protection purposes and the Counter Electronics High Powered Microwave Advanced Missile Project (CHAMP) for disabling an adversary’s electronics while avoiding collateral damage. These programs, as well as other high energy laser weapon systems, have been tested and demonstrated, but have failed to transition to acquisition programs of record.

The committee notes that directed energy capabilities have the potential to support many operational missions in cost effective and efficient manners. In response to these factors, the committee recommends a provision that would amend section 806 of the Bob Stump National Defense Authorization Act for Fiscal Year 2003 (Public Law 107–314) to grant rapid acquisition authorities for directed energy weapon systems to accelerate the development and fielding of this technology and to help offset the gains of potential adversaries.

The committee notes that since 1960, the Department of Defense has invested more than \$6.0 billion in directed energy science and technology initiatives. However, the committee remains concerned that, despite this significant investment, the Department’s directed energy initiatives are not resourced at levels necessary to transition them to full-

scale acquisition programs. The committee notes with concern that years of investment have not to date resulted in any operational systems with high energy laser capability.

The committee highlights that the Defense Science Board Task Force on Directed Energy Weapon Systems and Technology Applications found that “directed energy offers promise as a transformational ‘game changer’ in military operations, able to augment and improve operational capabilities in many areas.” The task force further concluded that the range of potential applications is sufficient to warrant significantly increased attention to the scope and direction of efforts to assess, develop, and field appropriate laser, microwave, and millimeter wave weapons. Consistent with the findings of the task force, the committee believes that directed energy weapons systems offer significant benefits in terms of cost effectiveness, sustainability, magazine capabilities, and precision targeting. (Pages 46-47)

S.Rept. 114-255 also states:

High energy laser joint technology office

The budget request included \$42.3 million in PE 62890F for high energy laser research. The committee notes that this program element funds defense high energy laser applied research through the High Energy Laser Joint Technology Office. However, the committee is concerned that the Joint Technology Office has not received sufficient funding in recent years to drive the maturation of high energy laser technology. As an example, the committee notes with concern that no laser technologies have yet been fielded or deployed, despite promising development and field tests. Given the importance of directed energy weapons systems in general as noted elsewhere in this Act, and of high energy laser systems in particular, the committee is concerned that budget request for this program element will be insufficient for supporting the joint technology office. Accordingly, the committee recommends an increase of \$5.0 million in PE 62890F for the high energy laser joint technology office. (Pages 54-55)

S.Rept. 114-255 also states:

Directed energy systems prototyping

The budget request included no money in PE 64342D8Z for defense technology offsets. The committee notes with disappointment that the administration did not view it as a priority to request funds through this program element. Particularly with the high-profile emphasis placed on the Department of Defense’s Third Offset Strategy, the committee is disappointed to see this program be unfunded. In addition, as noted elsewhere in this report, the committee is deeply disappointed with how the technology offset funding enacted in fiscal year 2016 was allocated. As noted, none of the money was put towards directed energy, in contradiction to the clear intent of Congress that half of the money be used to bolster directed energy technologies. While the committee does not recommend additional unrestricted funds for the technology offsets program, the committee underscores that directed energy systems are still critical areas of work in need of greater support and attention. The committee believes that the Department needs to focus in particular on the transition from lab development to deployment and fielding. Consequently, the committee recommends a general increase of \$25.0 million in PE 64342D8Z to be used only for the purposes of directed energy systems prototyping. (Pages 59-60)

S.Rept. 114-255 also states:

Laser weapon system demonstrator

The Committee commends the Navy for initiating and funding the Laser Weapon Systems Demonstrator (LWSD) and believes that this is an important step toward maturing technologies that could ultimately enable the deployment of a shipboard maritime laser weapons system. While the Committee understands that the Navy

envisions transitioning laser weapons to a formal Program of Record in the 2020s, it appears that the Navy has not programmed funding beyond the LWSD sea-based tests to support the installation of LWSD on a DDG or for the design and procurement of a formal maritime laser program.

The committee expects that the Secretary of the Navy will keep the congressional defense committees updated on its plan to seamlessly transition the LWSD to a shipboard weapons system following sea-based testing and to a formal maritime laser Program of Record, technical progress toward developing the capability, and programmatic steps being taken to move to demonstration and deployment of advanced laser systems. (Page 70)

Conference

The conference report (H.Rept. 114-840 of November 30, 2016) on S. 2943/P.L. 114-328 of December 23, 2016, recommended the funding levels shown in the authorization conference column of **Table 1**. The recommended reduction of \$2 million for PE 0603673N, Future Naval Capabilities Advanced Technology Development (line 21), is for “Capable manpower, and power and energy.” (Page 1397) The recommended reduction of \$15 million for PE 0604250D8Z, Advanced Innovative Technology (line 95) is for “SCO” (Strategic Capabilities Office) (Page 1419)

Section 219 of S. 2943/P.L. 114-328 states:

SEC. 219. Designation of Department of Defense senior official with principal responsibility for directed energy weapons.

(a) Designation of senior official.—

(1) IN GENERAL.—Not later than 180 days after the date of the enactment of this Act, the Secretary of Defense shall designate a senior official already serving within the Department of Defense as the official with principal responsibility for the development and demonstration of directed energy weapons for the Department.

(2) DEVELOPMENT OF STRATEGIC PLAN.—

(A) IN GENERAL.—The senior official designated under paragraph (1) shall develop a detailed strategic plan to develop, mature, and transition directed energy technologies to acquisition programs of record.

(B) ROADMAP.—Such strategic plan shall include a strategic roadmap for the development and fielding of directed energy weapons and key enabling capabilities for the Department, identifying and coordinating efforts across military departments to achieve overall joint mission effectiveness.

(3) ACCELERATION OF DEVELOPMENT AND FIELDING OF DIRECTED ENERGY WEAPONS CAPABILITIES.—

(A) IN GENERAL.—To the degree practicable, the senior official designated under paragraph (1) shall use the flexibility of the policies of the Department in effect on the day before the date of the enactment of this Act, or any successor policies, to accelerate the development and fielding of directed energy capabilities.

(B) ENGAGEMENT.—The Secretary shall use the flexibility of the policies of the Department in effect on the day before the date of the enactment of this Act, or any successor policies, to ensure engagement with defense and private industries, research universities, and unaffiliated, nonprofit research institutions.

(4) ADVICE FOR EXERCISES AND DEMONSTRATIONS.—The senior official designated under paragraph (1) shall, to the degree practicable, provide technical advice

and support to entities in the Department of Defense and the military departments conducting exercises or demonstrations with the purpose of improving the capabilities of or operational viability of technical capabilities supporting directed energy weapons, including supporting military utility assessments of the relevant cost and benefits of directed energy weapon systems.

(5) SUPPORT FOR DEVELOPMENT OF REQUIREMENTS.—The senior official designated under paragraph (1) shall coordinate with the military departments, Defense Agencies, and the Joint Directed Energy Transition Office to define requirements for directed energy capabilities that address the highest priority warfighting capability gaps of the Department.

(6) AVAILABILITY OF INFORMATION.—The Secretary of Defense shall ensure that the senior official designated under paragraph (1) has access to such information on programs and activities of the military departments and other defense agencies as the Secretary considers appropriate to coordinate departmental directed energy efforts.

(b) Joint Directed Energy Transition Office.—

(1) REDESIGNATION.—The High Energy Laser Joint Technology Office of the Department of Defense is hereby redesignated as the “Joint Directed Energy Transition Office” (in this subsection referred to as the “Office”), and shall report to the official designated under subsection (a)(1).

(2) ADDITIONAL FUNCTIONS.—In addition to the functions and duties of the Office in effect on the day before the date of the enactment of this Act, the Office shall assist the senior official designated under paragraph (1) of subsection (a) in carrying out paragraphs (2) through (5) of such subsection.

(3) FUNDING.—The Secretary may make available such funds to the Office for basic research, applied research, advanced technology development, prototyping, studies and analyses, and organizational support as the Secretary considers appropriate to support the efficient and effective development of directed energy systems and technologies and transition of those systems and technologies into acquisition programs or operational use.

Regarding Section 219, H.Rept. 114-840 states:

Designation of Department of Defense senior official with principal responsibility for directed energy weapons (sec. 219)

The Senate bill contained a provision (sec. 216) that would grant rapid acquisition authorities for directed energy weapons systems to accelerate the development and fielding of directed energy technology and to help offset the gains of potential adversaries. The Senate provision would also establish a joint directed energy program office at the Department of Defense.

The House amendment contained a provision (sec. 220) that would require the Secretary of Defense to designate a senior official already serving within the Department of Defense as a senior official with principal responsibility for the development and demonstration of directed energy weapons for the Department.

The Senate recedes with an amendment that would require the senior designated official to develop a strategic roadmap for the development and fielding of directed energy technology and to accelerate such development and fielding. The amendment would also rename the joint technology office for high energy lasers to the joint directed energy transition office, and would expand its mission to work with the senior designated official to push the demonstration and transition of directed energy systems, as well as the development of key technologies.

The conferees expect and encourage the Department of Defense to use rapid acquisition authorities authorized to the department in Section 806 of the Bob Stump National

Defense Authorization Act for Fiscal Year 2003 (Public Law 107–314; 10 U.S.C. 2302 note) to speed the development and deployment of operational directed energy capabilities. The committee believes that this provision allows the Secretary of Defense to better use the range of acquisition authorities already at the disposal of the department for the purposes of directed energy weapons system acquisition, including:

- (1) Rapid acquisition authority provided under Section 806;
- (2) Use of other transactions authority provided under section 2371 of Title 10, United States Code;
- (3) Simplified acquisition procedures for the acquisition of commercial items; and
- (4) Authority for procurement for experimental purposes provided under section 2373 of Title 10, United States Code. (Pages 219-220)

FY2017 DOD Appropriations Act (H.R. 5293/S. 3000/H.R. 244 /P.L. 115-31)

House (Committee Report)

The House Appropriations Committee, in its report (H.Rept. 114-577 of May 19, 2016) on H.R. 5293 of the 114th Congress, recommended the funding levels shown in the HAC column of **Table 1**. The recommended reduction of \$8 million to PE 0602750N, Future Naval Capabilities Applied Research (line 13) is for “FORCENET excessive growth” (\$5 million), “Power and energy previously funded efforts” (\$2 million), and “Sea shield previously funded efforts” (\$1 million). (Page 228) The recommended reduction of \$19.8 million to PE 0603114N, Power Projection Advanced Technology (line 16) is for “Precision strike technology excess growth.” (Page 228) The recommended net reduction of \$3 million to PE 0603673N, Future Naval Capabilities Advanced Technology Development (line 21) consists of a reduction of \$2 million for “Power and energy previously funded efforts,” a reduction of \$2 million for “Sea shield previously funded efforts,” and an increase of \$7 million for “Program increase—ASW [antisubmarine warfare] research.” (Page 228)

H.Rept. 114-577 states:

HIGH ENERGY LASERS

The Committee is aware of efforts within the High Energy Laser Joint Technology Office to develop advanced, directed-energy, high energy laser weapons that have the potential to perform a wide variety of military missions. The Committee encourages the Secretary of Defense to explore further development and evaluation of this important technology. (Page 264)

A June 14, 2016, statement of Administration policy on H.R. 5293 as reported states:

Navy High Energy Lasers. The Administration objects to the reduction of \$20 million from the FY 2017 Budget request for the Power Projection Advanced Technology program [line 16 in **Table 1**], which would delay by one year fielding of the High Energy Laser (HEL) program laser and demonstration of its technology maturation. The HEL technology is a means of countering low-cost unmanned aerial vehicles and small surface vessels.⁶¹

⁶¹ Executive Office of the President, *Statement of Administration Policy, H.R. 5293—Department of Defense* (continued...)

House (Floor Consideration)

On June 15, 2016, as part of its consideration of H.R. 5293 of the 114th Congress, the House agreed to by voice vote H.Amdt. 1185, which was amendment 11 printed in H.Rept. 114-623 of June 14, 2016, on H.Res. 783, providing for further consideration of H.R. 5293. H.Amdt. 1185 increased the Navy’s research and development account by \$29.8 million and reduced the Defense-Wide research and development account by \$33.9 million. H.Rept. 114-623 states that the \$29.8 million is for “Navy programs for the development and demonstration of advanced technologies, including high energy lasers and the Electromagnetic Railgun for naval weapon systems.” (Page 4)

Representative Langevin, in offering the amendment, stated that it “tracks the funds authorized in the FY17 NDAA” (i.e., the FY2017 National Defense Authorization Act—H.R. 4909) and “also provides for the mount for the rail gun....” Representative Conaway, speaking in support of the amendment, stated that it would “restore the funding for the directed energy weapons and rail gun.” Representative Frelinghuysen, speaking in opposition to the amendment, said it would “restore a funding reduction and increase funding above the President's budget request for the Navy power projection advanced technology line [i.e., line 16 in **Table 1**].”

Senate

The Senate Appropriations Committee, in its report (S.Rept. 114-263 of May 26, 2016) on S. 3000 of the 114th Congress, recommended the funding levels shown in the SAC column of **Table 1**. The recommended increase of \$20 million for PE 0602114N, Power Projection Applied Research (line 4) is for “Program increase.” (Page 154) The recommended increase of \$10 million for PE 0603673N, Future Naval Capabilities Advanced Technology Development (line 21) is for “Program increase.” (Page 154) The recommended reduction of \$15 million for PE 0604250D8Z, Advanced Innovative Technology (line 95) is for “Maintain program affordability: Program efficiencies.” (Page 179)

S.Rept. 114-263 states:

High Energy Laser.—The Committee is concerned with the funding levels for the primary test and evaluation facility for high energy laser [HEL] systems across the Department of Defense. With directed energy interest and work increasing in the third offset strategy, the Committee recommends the Department review the funding levels, identify, and correct shortfalls as necessary. (Page 180)

Conference

The final version of the FY2017 DOD appropriations act is Division C of H.R. 244/P.L. 115-31 of May 5, 2017, the Consolidated Appropriations Act, 2017. The explanatory statement for Division C of H.R. 244/P.L. 115-31 provides the funding levels shown in the appropriation conference column of **Table 1**. The increase of \$20 million for PE 0602114N, Power Projection Applied Research (line 4) is for “Program increase.” (PDF page 228 of 372) The reduction of \$8 million for PE 0602750N, Future Naval Capabilities Applied Research (line 13), includes a reduction of \$5 million for “FORCENET growth,” a reduction of \$2 million for “Power and energy previously funded efforts,” and a reduction of \$1 million for “Sea shield previously funded efforts.” (PDF page 228 of 372) The increase of \$17 million for PE 0603673N, Future Naval Capabilities

(...continued)

Appropriations Act, 2017, June 14, 2016, p. 6.

Advanced Technology Development (line 21), includes an increase of \$7 million for “Program increase—ASW [antisubmarine warfare] research” and an increase of \$10 million for “Program increase.” (PDF page 228 of 372) The reduction of \$10 million for PE 0604250D8Z, Advanced Innovative Technology (line 95), is for “Program decrease.” (PDF page 263 of 372)

Directed Energy Weapon Systems Acquisition Act of 2016 (H.R. 4964/S. 2778)

House

H.R. 4964 of the 114th Congress was introduced in the House on May 5, 2016. The text of H.R. 4964 as introduced states:

SECTION 1. Short title.

This Act may be cited as the “Directed Energy Weapon Systems Acquisition Act of 2016”.

SEC. 2. Findings.

Congress makes the following findings:

(1) The Committee on Armed Services of the Senate noted in the report accompanying S. 1356 (S.Rept. 114-49; 114th Congress) that since 1960, the Department of Defense has invested more than \$6,000,000,000 in directed energy science and technology initiatives, and that the Committee is concerned that, despite this significant investment, the Department's directed energy initiatives are not resourced at levels necessary to transition them to full-scale acquisition programs.

(2) The Defense Science Board Task Force on Directed Energy Weapon Systems and Technology Applications (the “Task Force”) found that “directed energy offers promise as a transformational ‘game changer’ in military operations, able to augment and improve operational capabilities in many areas”.

(3) Despite this potential, years of investment have not resulted in any operational systems with high energy laser capability.

(4) The Task Force believes that the range of potential application is sufficient to warrant significantly increased attention to the scope and direction of efforts to assess, develop, and field appropriate laser, microwave, and millimeter wave weapons.

SEC. 3. Inclusion of directed energy weapon system programs in the rapid acquisition authority program.

(a) In general.—Section 806(c)(1) of the Bob Stump National Defense Authorization Act for Fiscal Year 2003 (Public Law 107-314; 10 U.S.C. 2302 note) is amended by adding at the end the following new subparagraph:

“(D) (i) In the case of any supplies and associated support services that, as determined in writing by the Secretary of Defense without delegation, are urgently needed to eliminate a deficiency in directed energy weapon systems, the Secretary may use the procedures developed under this section in order to accomplish the rapid acquisition and deployment of needed offensive or defensive directed energy weapon systems capabilities, supplies, and associated support services.

“(ii) For the purposes of directed energy weapon systems acquisition, the Secretary of Defense shall consider use of the following procedures:

“(I) The rapid acquisition authority provided under this section.

“(II) Use of other transactions authority provided under section 2371 of title 10, United States Code.

“(III) The acquisition of commercial items using simplified acquisition procedures.

“(IV) The authority for procurement for experimental purposes provided under section 2373 of title 10, United States Code.

“(iii) In this subparagraph, the term ‘directed energy weapon system’ means military action involving the use of directed energy to incapacitate, damage, or destroy enemy equipment, facilities, or personnel.”.

(b) Conforming amendments.—Section 2373 of title 10, United States Code, is amended—

(1) in subsection (a), by striking “and aeronautical supplies” and inserting “, aeronautical supplies, and directed energy weapon systems”; and

(2) by adding at the end of the following new subsection:

“(c) Directed energy weapon system defined.—In this section, the term ‘directed energy weapon system’ means military action involving the use of directed energy to incapacitate, damage, or destroy enemy equipment, facilities, or personnel.”.

SEC. 4. Joint Directed Energy Program Office.

(a) Redesignation.—The High Energy Laser Joint Technology Office of the Department of Defense is hereby redesignated as the “Joint Directed Energy Program Office” (in this section referred to as the “Office”).

(b) Strategic plan for development and transition of directed energy weapons capabilities toward fielding.—In addition to the functions and duties of the Office in effect on the day before the date of the enactment of this Act, the Office shall develop a strategic plan for development and transition of directed energy weapons capabilities toward fielding for the Department, in which the Office may define requirements for directed energy capabilities that address the highest priority warfighting capability gaps of the Department.

(c) Acceleration of development and transition of directed energy weapons capabilities toward fielding.—

(1) IN GENERAL.—To the degree practicable, the Office shall use the policies of the Department that are revised pursuant to this Act and new acquisition and management practices established pursuant to this Act to accelerate the development and transition of directed energy capabilities toward fielding.

(2) ENGAGEMENT.—The Secretary shall ensure that use of policies and practices described in paragraph (1) include engagement with defense and private industries, research universities, and unaffiliated, nonprofit research institutions.

Senate

S. 2778 of the 114th Congress was introduced in the Senate on April 12, 2016. The text of S. 2778 as introduced states:

SECTION 1. Short title.

This Act may be cited as the “Directed Energy Weapon Systems Acquisition Act of 2016”.

SEC. 2. Findings.

Congress makes the following findings:

(1) The Committee on Armed Services of the Senate noted in the report accompanying S. 1356 (S.Rept. 114-49; 114th Congress) that since 1960, the Department of Defense has invested more than \$6,000,000,000 in directed energy science and technology initiatives, and that the Committee is concerned that, despite this significant investment, the Department's directed energy initiatives are not resourced at levels necessary to transition them to full-scale acquisition programs.

(2) The Defense Science Board Task Force on Directed Energy Weapon Systems and Technology Applications (the "Task Force") found that "directed energy offers promise as a transformational 'game changer' in military operations, able to augment and improve operational capabilities in many areas".

(3) Despite this potential, years of investment have not resulted in any operational systems with high energy laser capability.

(4) The Task Force believes that the range of potential application is sufficient to warrant significantly increased attention to the scope and direction of efforts to assess, develop, and field appropriate laser, microwave, and millimeter wave weapons.

SEC. 3. Inclusion of directed energy weapon system programs in the rapid acquisition authority program.

(a) In general.—Section 806(c)(1) of the Bob Stump National Defense Authorization Act for Fiscal Year 2003 (Public Law 107–314; 10 U.S.C. 2302 note) is amended by adding at the end the following new subparagraph:

“(D) (i) In the case of any supplies and associated support services that, as determined in writing by the Secretary of Defense without delegation, are urgently needed to eliminate a deficiency in directed energy weapon systems, the Secretary may use the procedures developed under this section in order to accomplish the rapid acquisition and deployment of needed offensive or defensive directed energy weapon systems capabilities, supplies, and associated support services.

“(ii) For the purposes of directed energy weapon systems acquisition, the Secretary of Defense shall consider use of the following procedures:

“(I) The rapid acquisition authority provided under this section.

“(II) Use of other transactions authority provided under section 2371 of title 10, United States Code.

“(III) The acquisition of commercial items using simplified acquisition procedures.

“(IV) The authority for procurement for experimental purposes provided under section 2373 of title 10, United States Code.

“(iii) In this subparagraph, the term ‘directed energy weapon system’ means military action involving the use of directed energy to incapacitate, damage, or destroy enemy equipment, facilities, or personnel.”.

(b) Conforming amendments.—Section 2373 of title 10, United States Code, is amended—

(1) in subsection (a), by striking “and aeronautical supplies” and inserting “, aeronautical supplies, and directed energy weapon systems”; and

(2) by adding at the end the following new subsection:

“(c) Directed energy weapon system defined.—In this section, the term ‘directed energy weapon system’ means military action involving the use of directed energy to incapacitate, damage, or destroy enemy equipment, facilities, or personnel.”.

SEC. 4. Joint Directed Energy Program Office.

(a) Redesignation.—The High Energy Laser Joint Technology Office of the Department of Defense is hereby redesignated as the “Joint Directed Energy Program Office” (in this section referred to as the “Office”).

(b) Strategic plan for development and transition of directed energy weapons capabilities toward fielding.—In addition to the functions and duties of the Office in effect on the day before the date of the enactment of this Act, the Office shall develop a strategic plan for development and transition of directed energy weapons capabilities toward fielding for the Department, in which the Office may define requirements for directed energy capabilities that address the highest priority warfighting capability gaps of the Department.

(c) Acceleration of development and transition of directed energy weapons capabilities toward fielding.—

(1) IN GENERAL.—To the degree practicable, the Office shall use the policies of the Department that are revised pursuant to this Act and new acquisition and management practices established pursuant to this Act to accelerate the development and transition of directed energy capabilities toward fielding.

(2) ENGAGEMENT.—The Secretary shall ensure that use of policies and practices described in paragraph (1) include engagement with defense and private industries, research universities, and unaffiliated, nonprofit research institutions.

Appendix. Potential Advantages and Limitations of Shipboard Lasers

This appendix presents additional information on potential advantages and limitations of shipboard lasers.

Potential Advantages

In addition to a low marginal cost per shot and deep magazine, potential advantages of shipboard lasers include the following:

- **Fast engagement times.** Light from a laser beam can reach a target almost instantly (eliminating the need to calculate an intercept course, as there is with interceptor missiles) and, by remaining focused on a particular spot on the target, cause disabling damage to the target within seconds. After disabling one target, a laser can be redirected in several seconds to another target.
- **Ability to counter radically maneuvering missiles.** Lasers can follow and maintain their beam on radically maneuvering missiles that might stress the maneuvering capabilities of Navy SAMs.
- **Precision engagements.** Lasers are precision-engagement weapons—the light spot from a laser, which might be several inches in diameter, affects what it hits, while generally not affecting (at least not directly) separate nearby objects.
- **Graduated responses.** Lasers can perform functions other than destroying targets, including detecting and monitoring targets and producing nonlethal effects, including reversible jamming of electro-optic (EO) sensors. Lasers offer the potential for graduated responses that range from warning targets to reversibly jamming their systems, to causing limited but not disabling damage (as a further warning), and then finally causing disabling damage.

Potential Limitations

Potential limitations of shipboard lasers include the following:

- **Line of sight.** Since laser light tends to fly through the atmosphere on an essentially straight path, shipboard lasers would be limited to line-of-sight engagements, and consequently could not counter over-the-horizon targets or targets that are obscured by intervening objects. This limits in particular potential engagement ranges against small boats, which can be obscured by higher waves, or low-flying targets. Even so, lasers can rapidly reacquire boats obscured by periodic swells.
- **Atmospheric absorption, scattering, and turbulence.** Substances in the atmosphere—particularly water vapor, but also things such as sand, dust, salt particles, smoke, and other air pollution—absorb and scatter light from a shipboard laser, and atmospheric turbulence can defocus a laser beam. These effects can reduce the effective range of a laser. Absorption by water vapor is a particular consideration for shipboard lasers because marine environments feature substantial amounts of water vapor in the air. There are certain wavelengths of light (i.e., “sweet spots” in the electromagnetic spectrum) where atmospheric absorption by water vapor is markedly reduced. Lasers can be

designed to emit light at or near those sweet spots, so as to maximize their potential effectiveness. Absorption generally grows with distance to target, making it in general less of a potential problem for short-range operations than for longer-range operations. Adaptive optics, which make rapid, fine adjustments to a laser beam on a continuous basis in response to observed turbulence, can counteract the effects of atmospheric turbulence. Even so, lasers might not work well, or at all, in rain or fog, preventing lasers from being an all-weather solution.

- **Thermal blooming.** A laser that continues firing in the same exact direction for a certain amount of time can heat up the air it is passing through, which in turn can defocus the laser beam, reducing its ability to disable the intended target. This effect, called thermal blooming, can make lasers less effective for countering targets that are coming straight at the ship, on a constant bearing (i.e., “down-the-throat” shots). Other ship self-defense systems, such as interceptor missiles or a CIWS, might be more suitable for countering such targets. Most tests of laser systems have been against crossing targets rather than “down-the-throat” shots. In general, thermal blooming becomes more of a concern as the power of the laser beam increases.
- **Saturation attacks.** Since a laser can attack only one target at a time, requires several seconds to disable it, and several more seconds to be redirected to the next target, a laser can disable only so many targets within a given period of time. This places an upper limit on the ability of an individual laser to deal with saturation attacks—attacks by multiple weapons that approach the ship simultaneously or within a few seconds of one another. This limitation can be mitigated by installing more than one laser on the ship, similar to how the Navy installs multiple CIWS systems on certain ships.
- **Hardened targets and countermeasures.** Less-powerful lasers—that is, lasers with beam powers measured in kilowatts (kW) rather than megawatts (MW)—can have less effectiveness against targets that incorporate shielding, ablative material, or highly reflective surfaces, or that rotate rapidly (so that the laser spot does not remain continuously on a single location on the target’s surface) or tumble. Small boats (or other units) could employ smoke or other obscurants to reduce their susceptibility to laser attack.⁶² Measures such as these, however, can increase the cost and/or weight of a weapon, and obscurants could make it more difficult for small boat operators to see what is around them, reducing their ability to use their boats effectively.
- **Risk of collateral damage to aircraft, satellites, and human eyesight.** Since light from an upward-pointing laser that does not hit the target would continue flying upward in a straight line, it could pose a risk of causing unwanted collateral damage to aircraft and satellites. The light emitted by SSLs being developed by the Navy is of a frequency that can cause permanent damage to human eyesight, including blinding. Blinding can occur at ranges much greater than ranges for damaging targeted objects. Scattering of laser light off the target or off fog or particulates in the air can pose a risk to exposed eyes.⁶³

⁶² See, for example, “Kelsey D. Atherton, “China Plans To Defeat American Lasers With Smoke,” *Popular Science*, May 3, 2016.

⁶³ The United States in 1995 ratified the 1980 Convention on Prohibitions or Restriction on the Use of Certain Conventional Weapons Which May be Deemed to be Excessively Injurious or to Have Indiscriminate Effects. An (continued...)

For additional background information on potential Navy shipboard SSLs, see CRS Report R41526, *Navy Shipboard Lasers for Surface, Air, and Missile Defense: Background and Issues for Congress*, by Ronald O'Rourke.

Author Contact Information

Ronald O'Rourke
Specialist in Naval Affairs
rorourke@crs.loc.gov, 7-7610

(...continued)

international review of the convention began in 1994 and concluded in May 1996 with the adoption of, among other things, a new Protocol IV on blinding laser weapons. The protocol prohibits the employment of lasers that are specifically designed to cause permanent blindness to the naked eye or to the eye with corrective eyesight devices. The United States ratified Protocol IV on December 23, 2008, and it entered into force for the United States on July 21, 2009. DOD views the protocol as fully consistent with DOD policy. DOD believes the lasers discussed in this report are consistent with DOD policy of prohibiting the use of lasers specifically designed to cause permanent blindness to the naked eye or to the eye with corrective eyesight devices. For further discussion, see Appendix I (“Protocol on Blinding Lasers”) in CRS Report R41526, *Navy Shipboard Lasers for Surface, Air, and Missile Defense: Background and Issues for Congress*, by Ronald O'Rourke.